

PROFILED PANEL SYSTEM
NOTE:
LOAD BEARING WALL COMPONENTS OF EITHER: 16GA STEEL STUDS, STRUCTURAL MEMBERS, MINIMUM 3/4" PLYWOOD OR CONCRETE. GYPSUM BOARD AND CEMENT BOARD ARE NOT A STRUCTURAL COMPONENT.

TYPICAL VERTICAL DETAIL (OPTION #1)

DETAIL A

NOTE:
 LOAD BEARING WALL COMPONENTS OF EITHER: 16GA STEEL STUDS, STRUCTURAL MEMBERS, MINIMUM 3/4" PLYWOOD OR CONCRETE. GYPSUM BOARD AND CEMENT BOARD ARE NOT A STRUCTURAL COMPONENT.

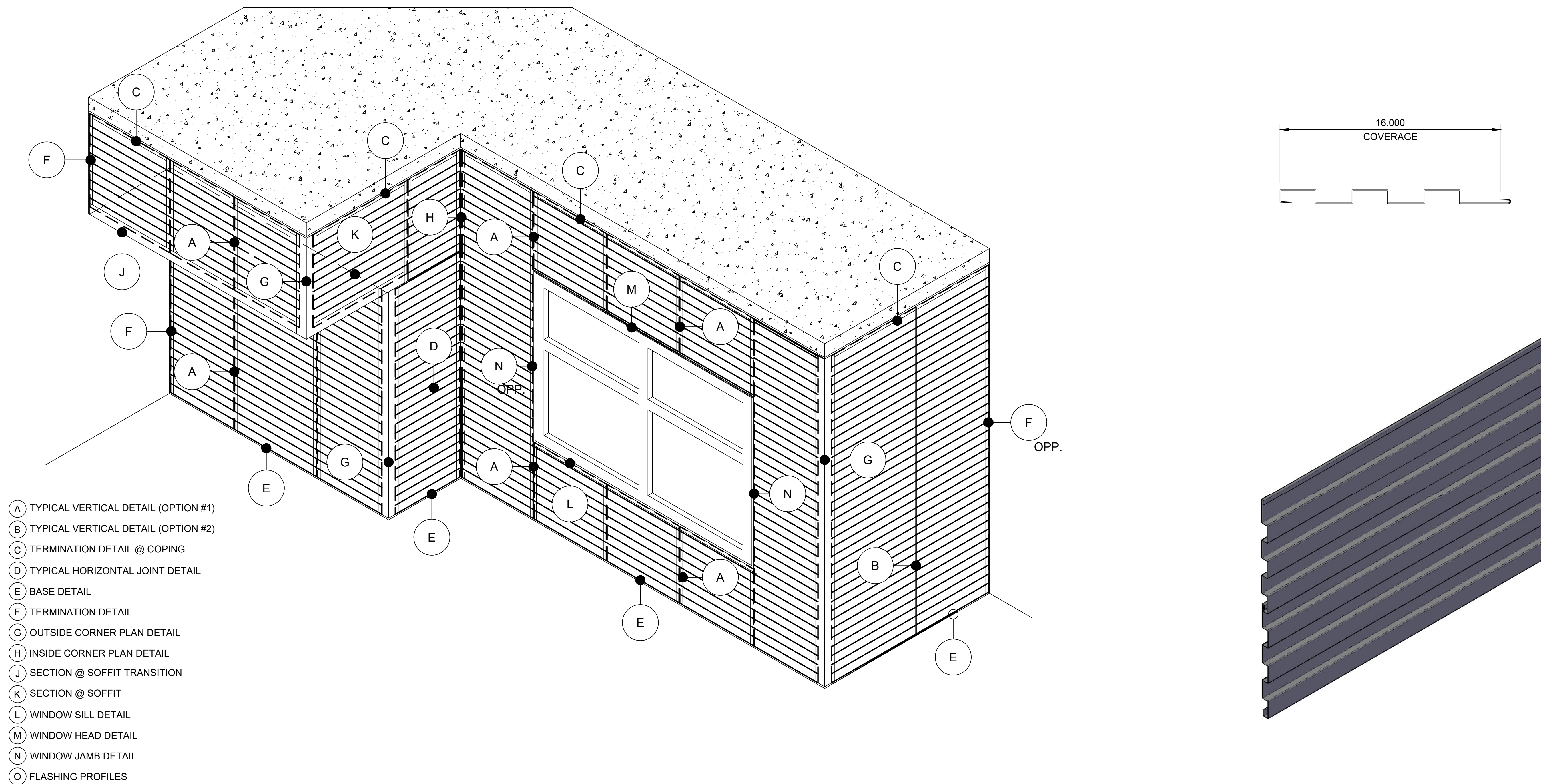
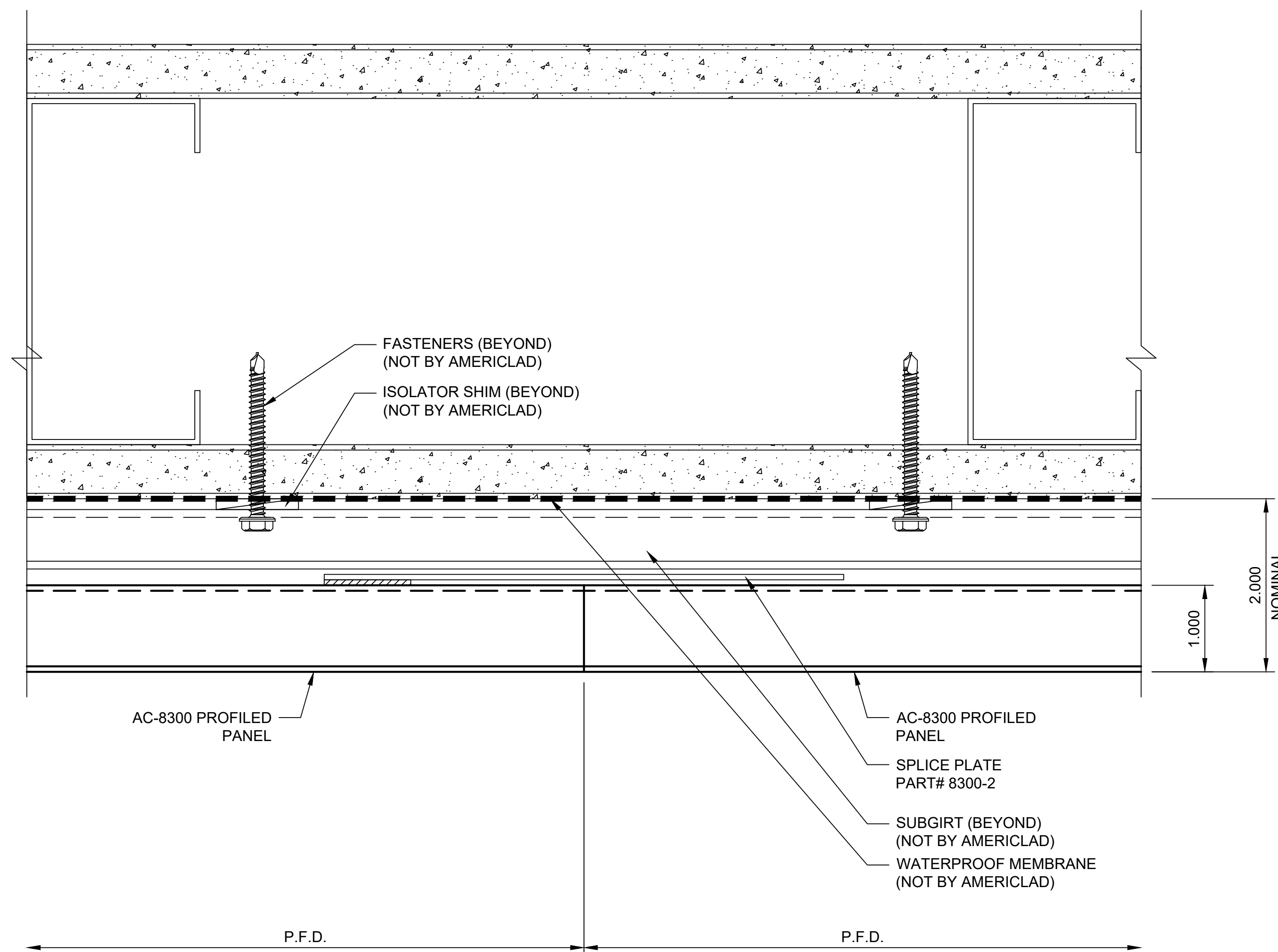

SYSTEM COMPONENTS

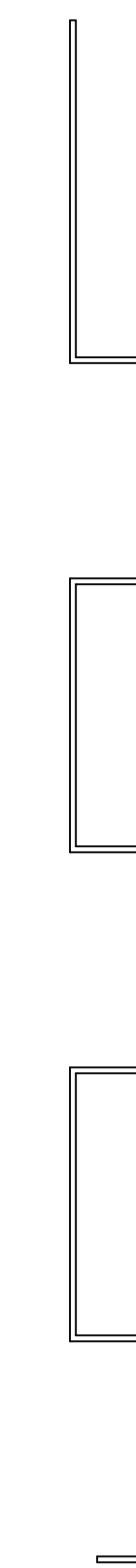

SPLICE PLATE
PART# 8300-2

NOTE: SPLICE PLATE SHOWN N.T.S.

TYPICAL VERTICAL DETAIL (OPTION #2)

DETAIL B

NOTE:
 LOAD BEARING WALL COMPONENTS OF EITHER: 16GA STEEL STUDS, STRUCTURAL MEMBERS, MINIMUM 3/4" PLYWOOD OR CONCRETE. GYPSUM BOARD AND CEMENT BOARD ARE NOT A STRUCTURAL COMPONENT.

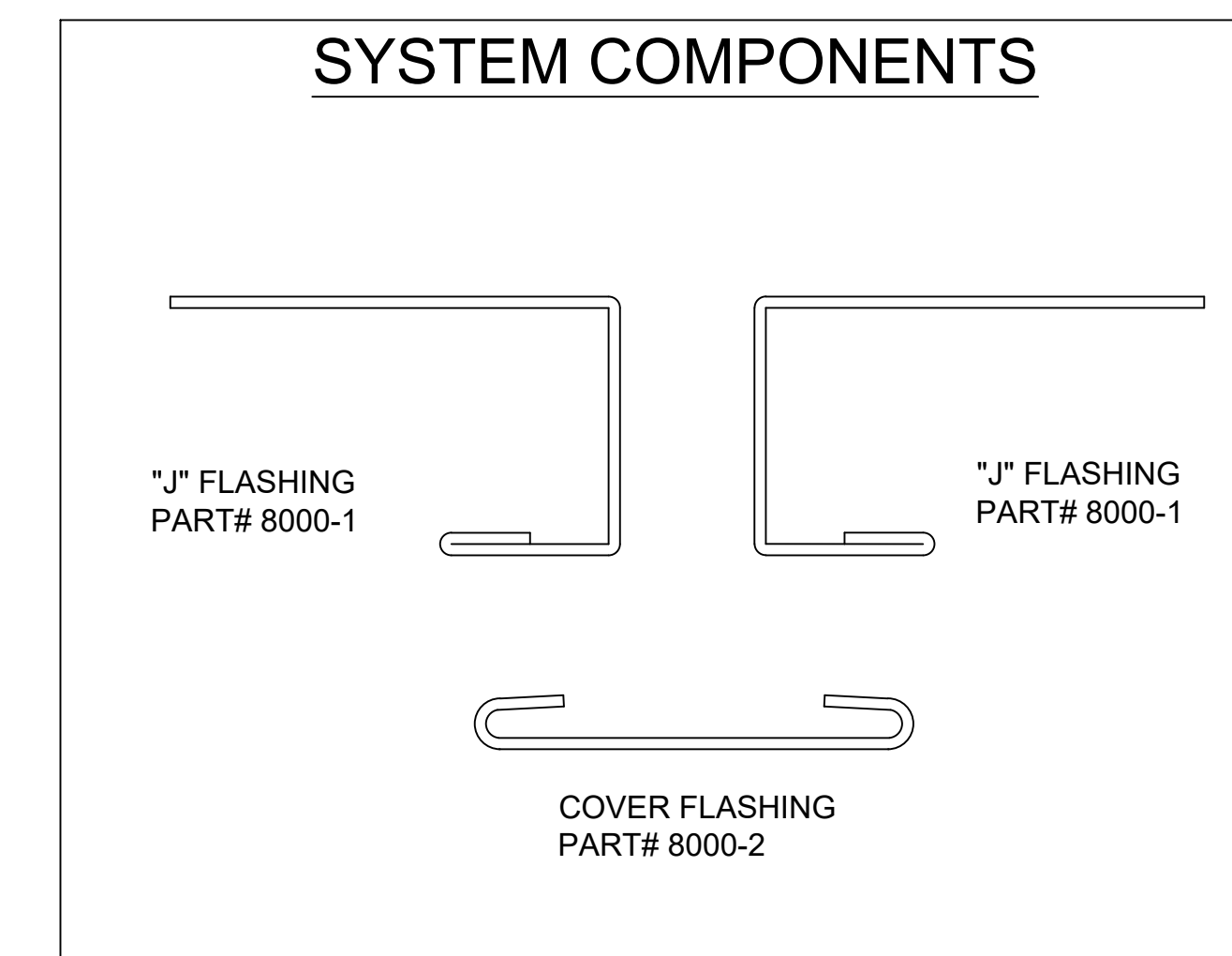
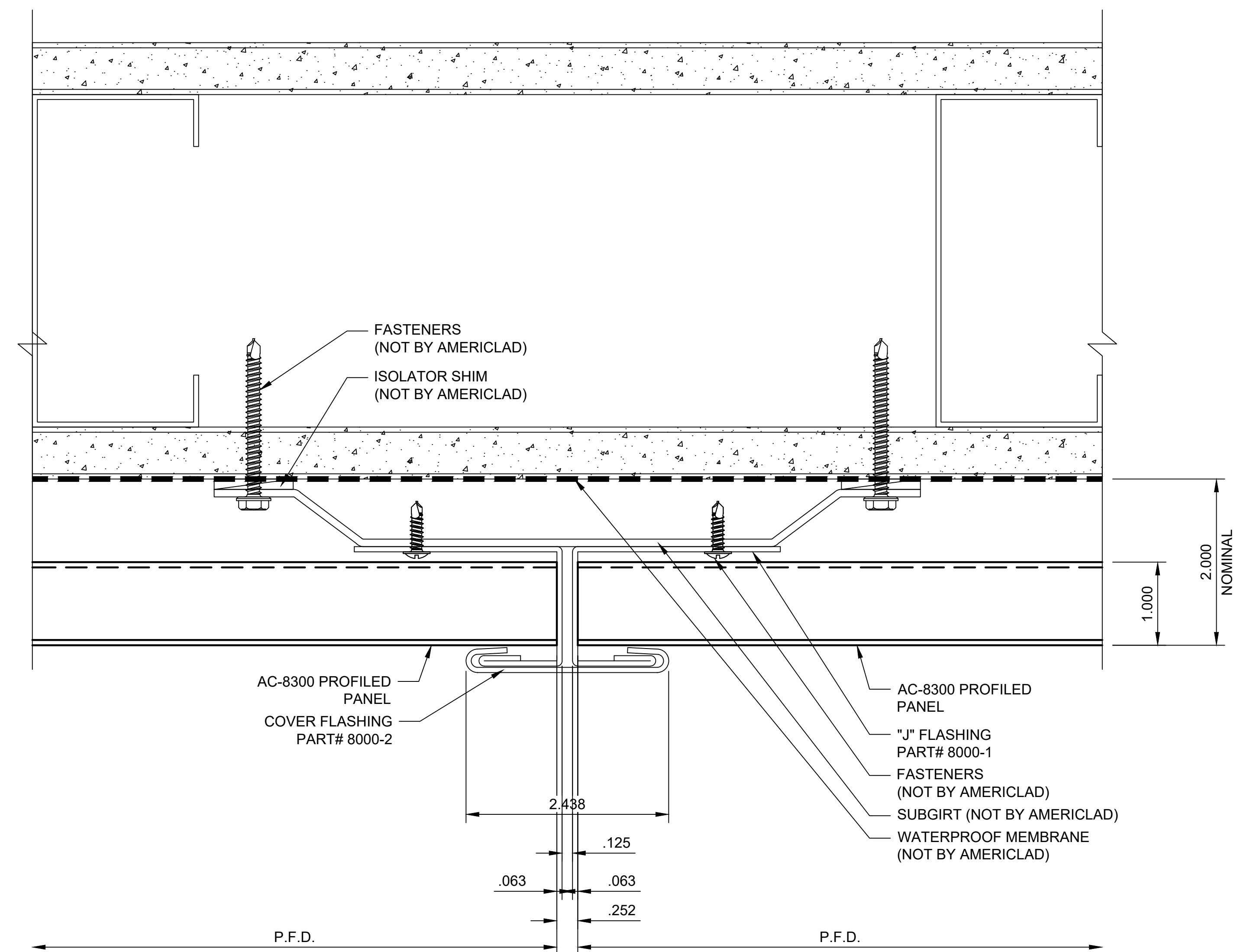

TERMINATION DETAIL @ COPING

DETAIL C

NOTE:
 LOAD BEARING WALL COMPONENTS OF EITHER: 16GA STEEL STUDS, STRUCTURAL MEMBERS, MINIMUM 3/4" PLYWOOD OR CONCRETE. GYPSUM BOARD AND CEMENT BOARD ARE NOT A STRUCTURAL COMPONENT.

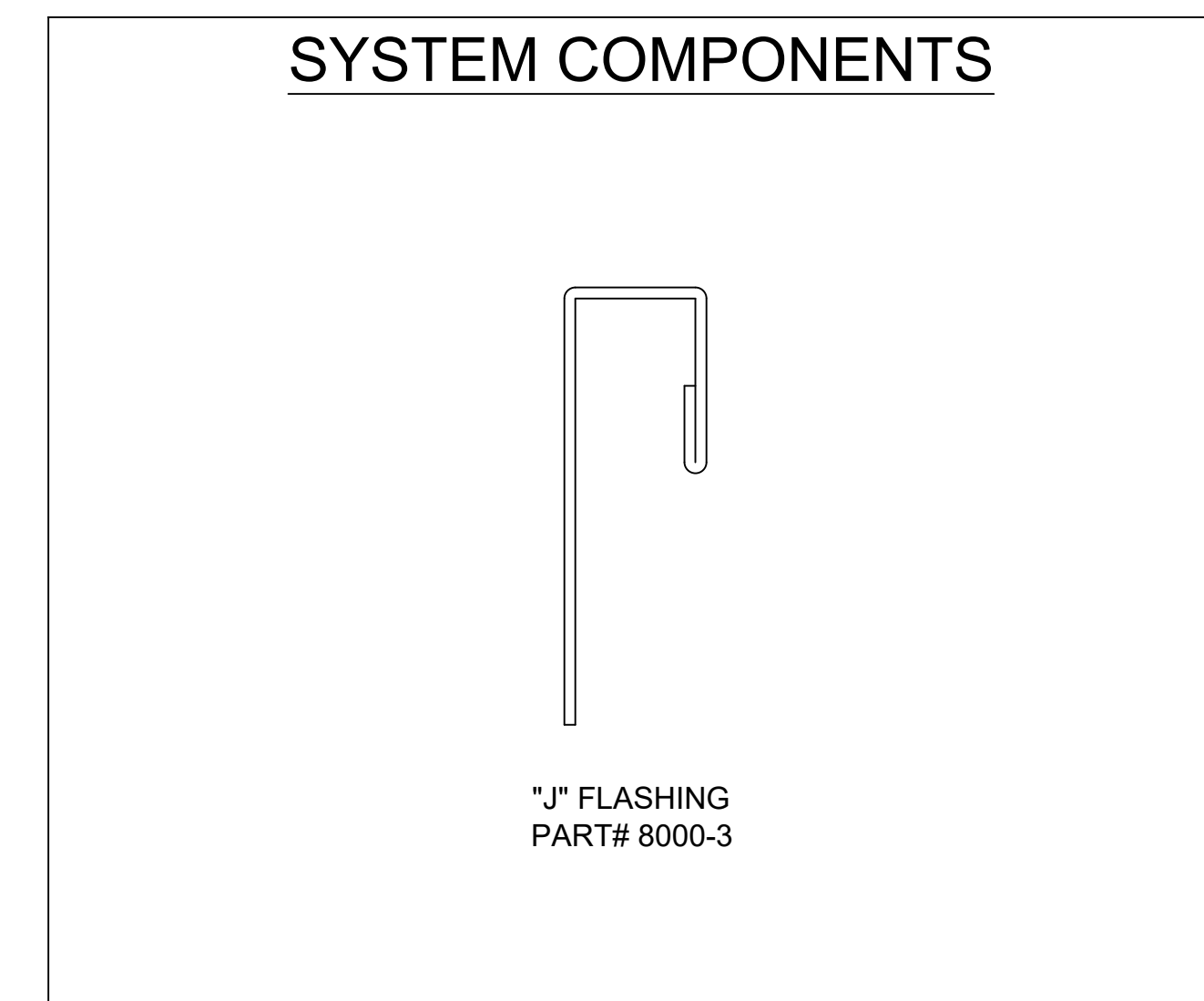
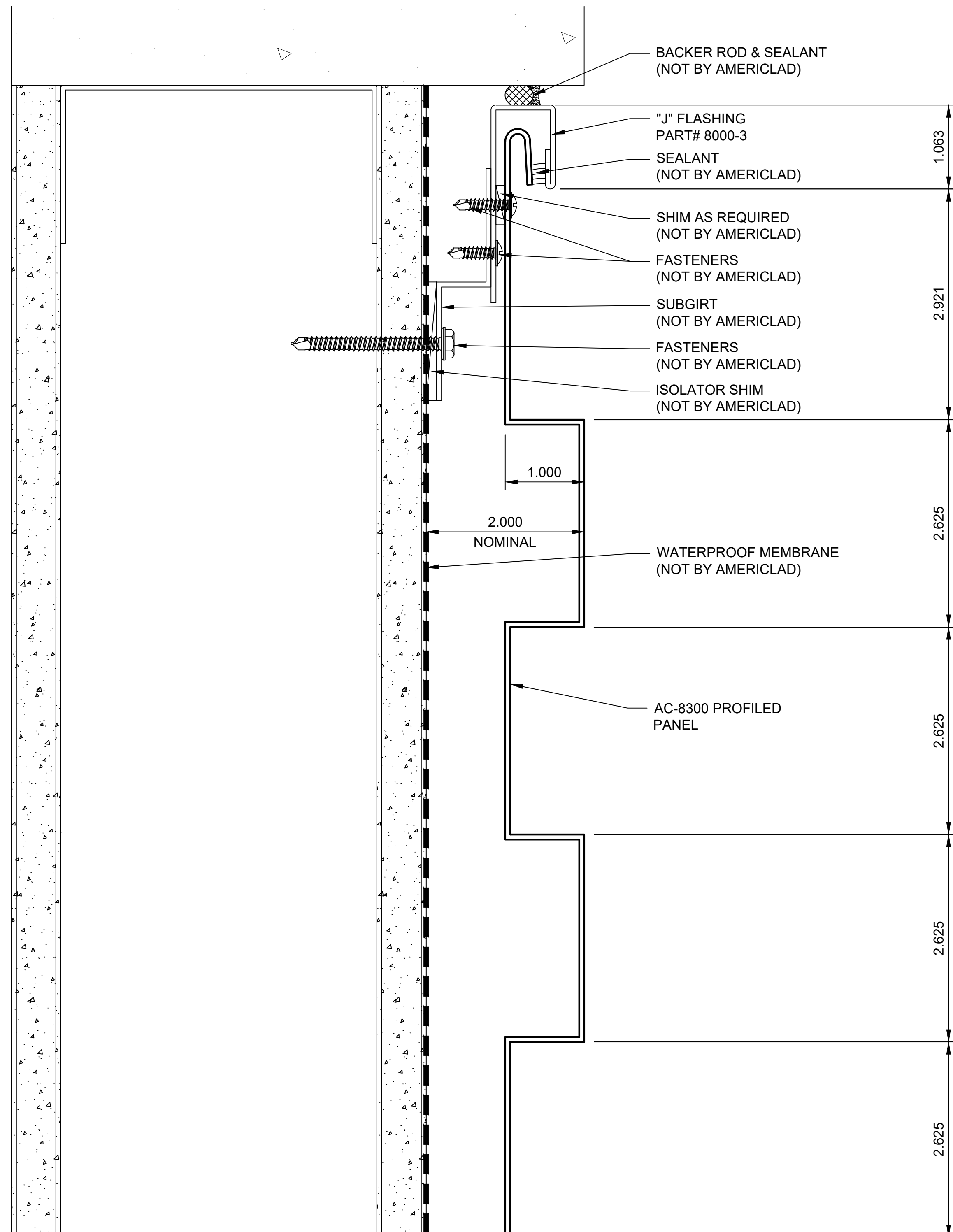

TYPICAL HORIZONTAL JOINT DETAIL

DETAIL D

NOTE:
 LOAD BEARING WALL COMPONENTS OF EITHER: 16GA STEEL STUDS, STRUCTURAL MEMBERS, MINIMUM 3/4" PLYWOOD OR CONCRETE. GYPSUM BOARD AND CEMENT BOARD ARE NOT A STRUCTURAL COMPONENT.

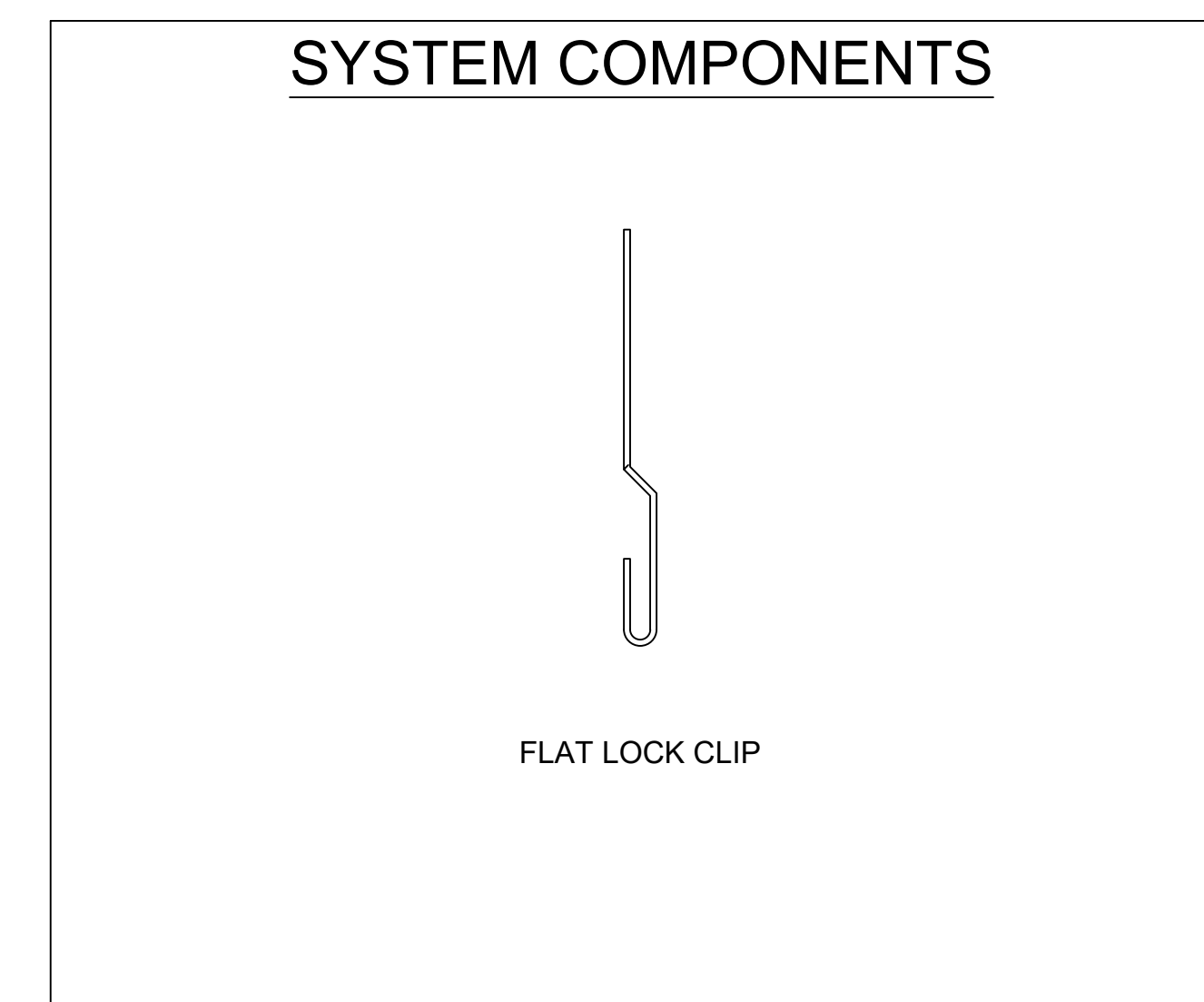
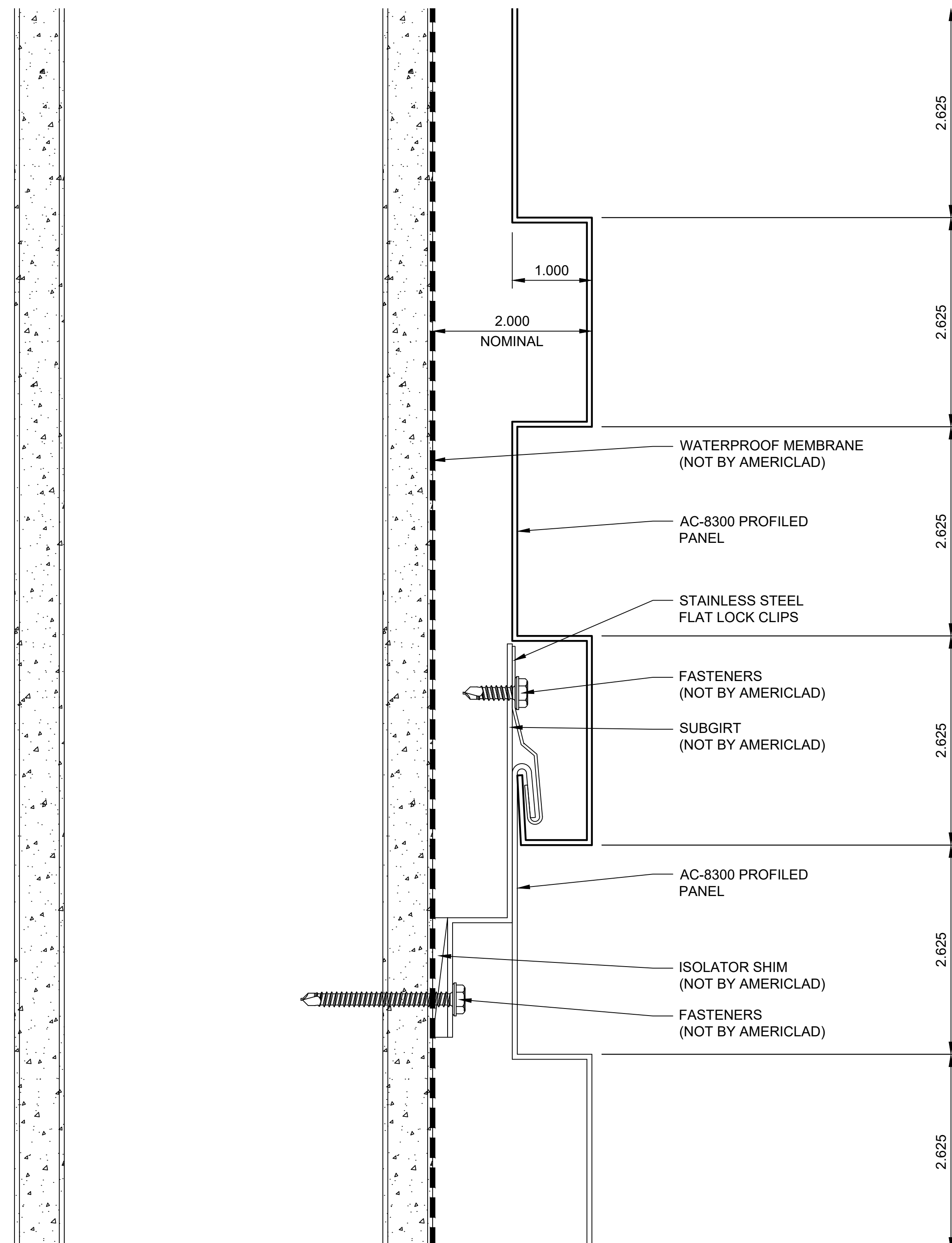

BASE DETAIL

DETAIL E

NOTE:
 LOAD BEARING WALL COMPONENTS OF EITHER: 16GA STEEL STUDS, STRUCTURAL MEMBERS, MINIMUM 3/4" PLYWOOD OR CONCRETE. GYPSUM BOARD AND CEMENT BOARD ARE NOT A STRUCTURAL COMPONENT.

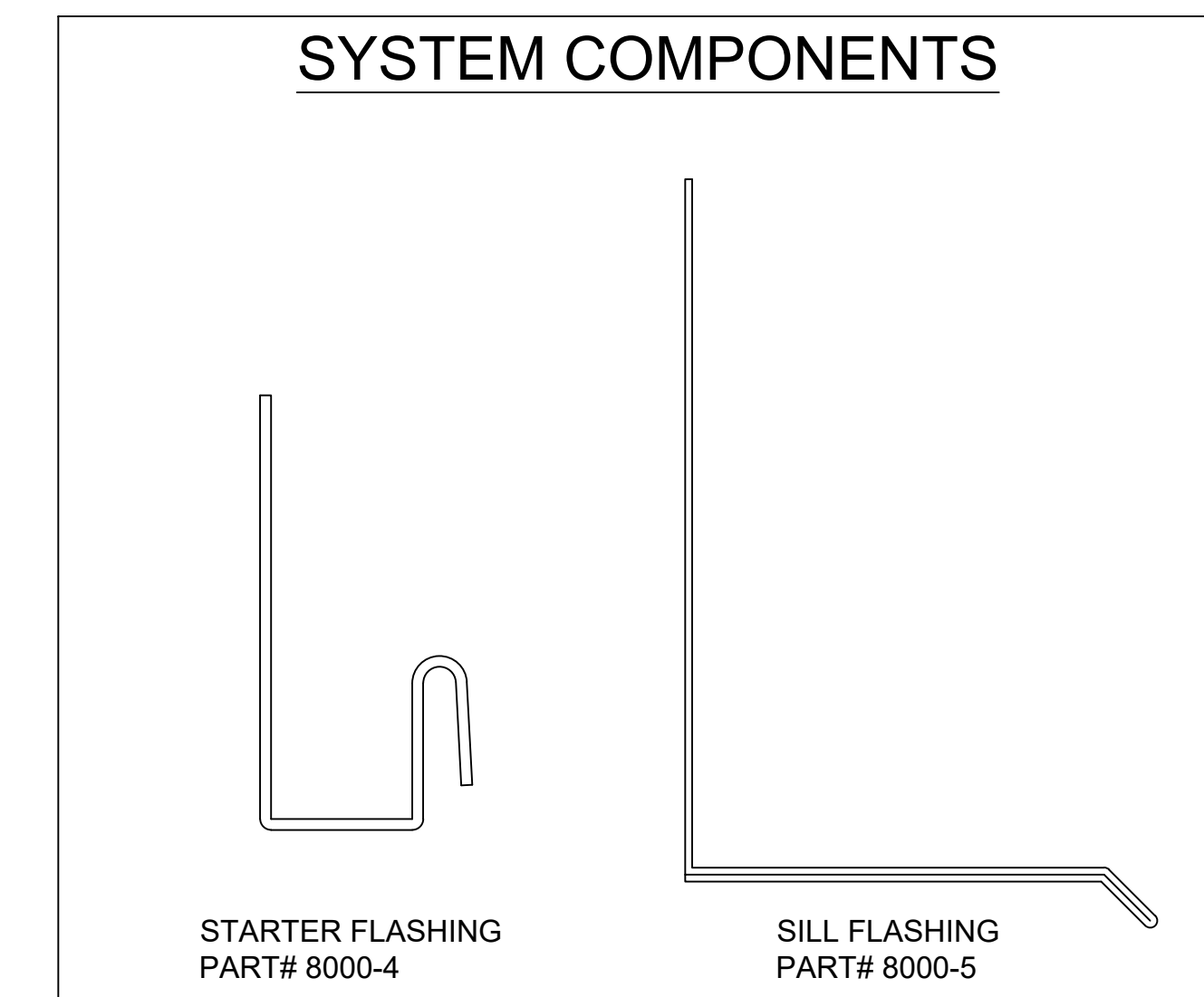
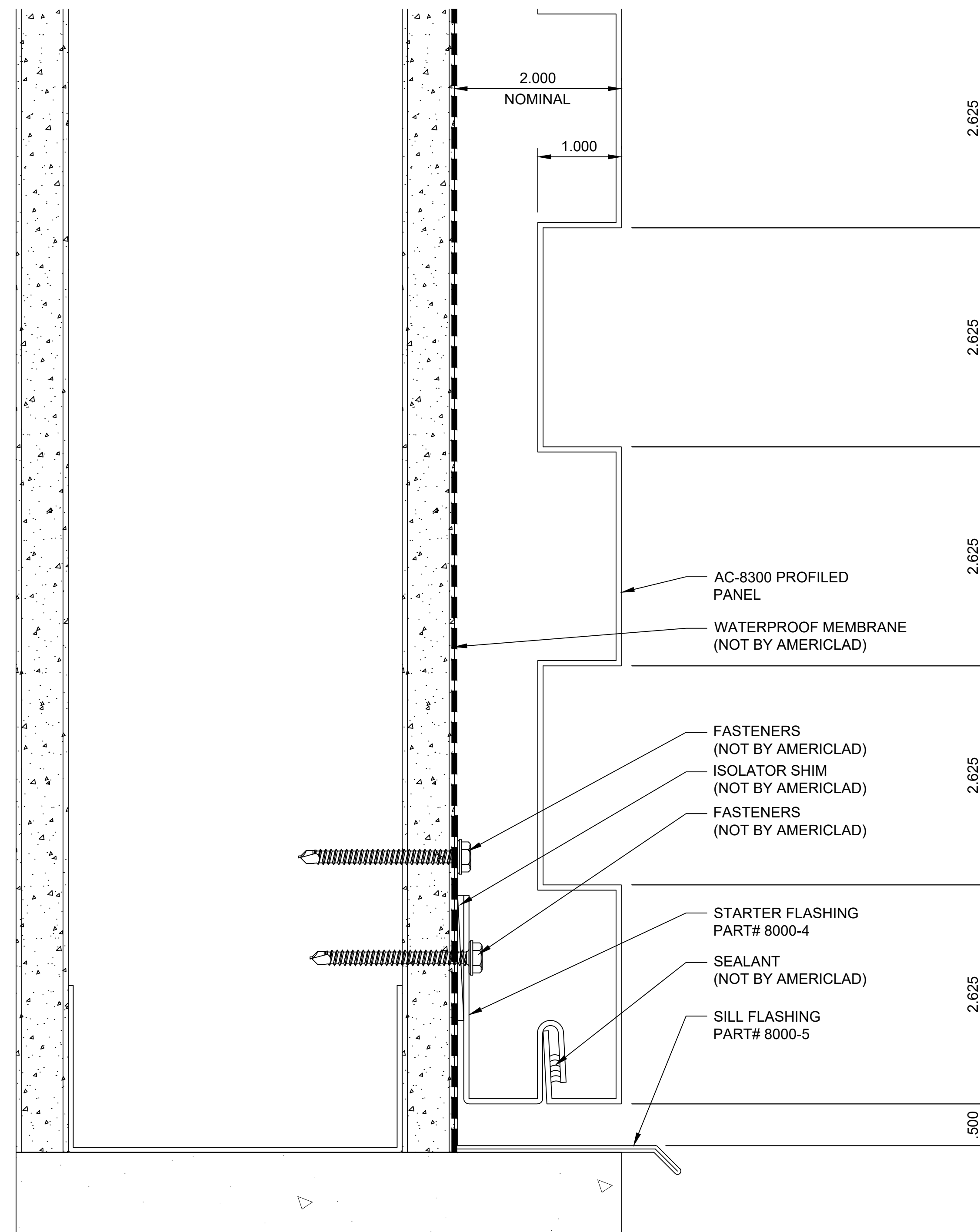

TERMINATION DETAIL

DETAIL F

NOTE:
LOAD BEARING WALL COMPONENTS OF EITHER: 16GA STEEL STUDS, STRUCTURAL MEMBERS, MINIMUM 3/4" PLYWOOD OR CONCRETE. GYPSUM BOARD AND CEMENT BOARD ARE NOT A STRUCTURAL COMPONENT.

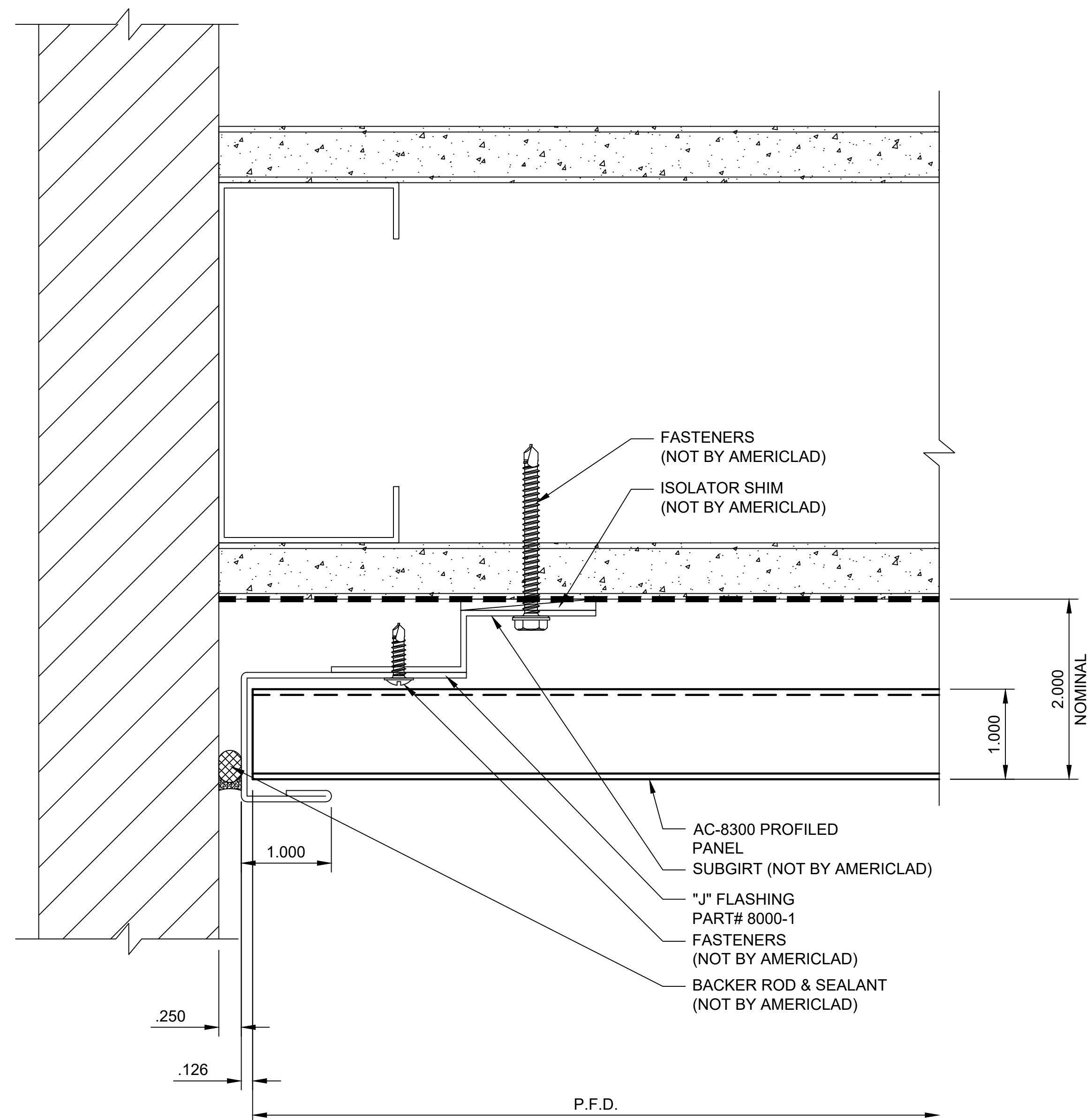

SYSTEM COMPONENTS

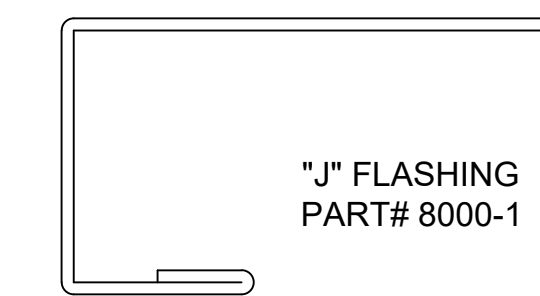

OUTSIDE CORNER PLAN DETAIL

DETAIL G

NOTE:
 LOAD BEARING WALL COMPONENTS OF EITHER: 16GA STEEL STUDS, STRUCTURAL MEMBERS, MINIMUM 3/4" PLYWOOD OR CONCRETE. GYPSUM BOARD AND CEMENT BOARD ARE NOT A STRUCTURAL COMPONENT.

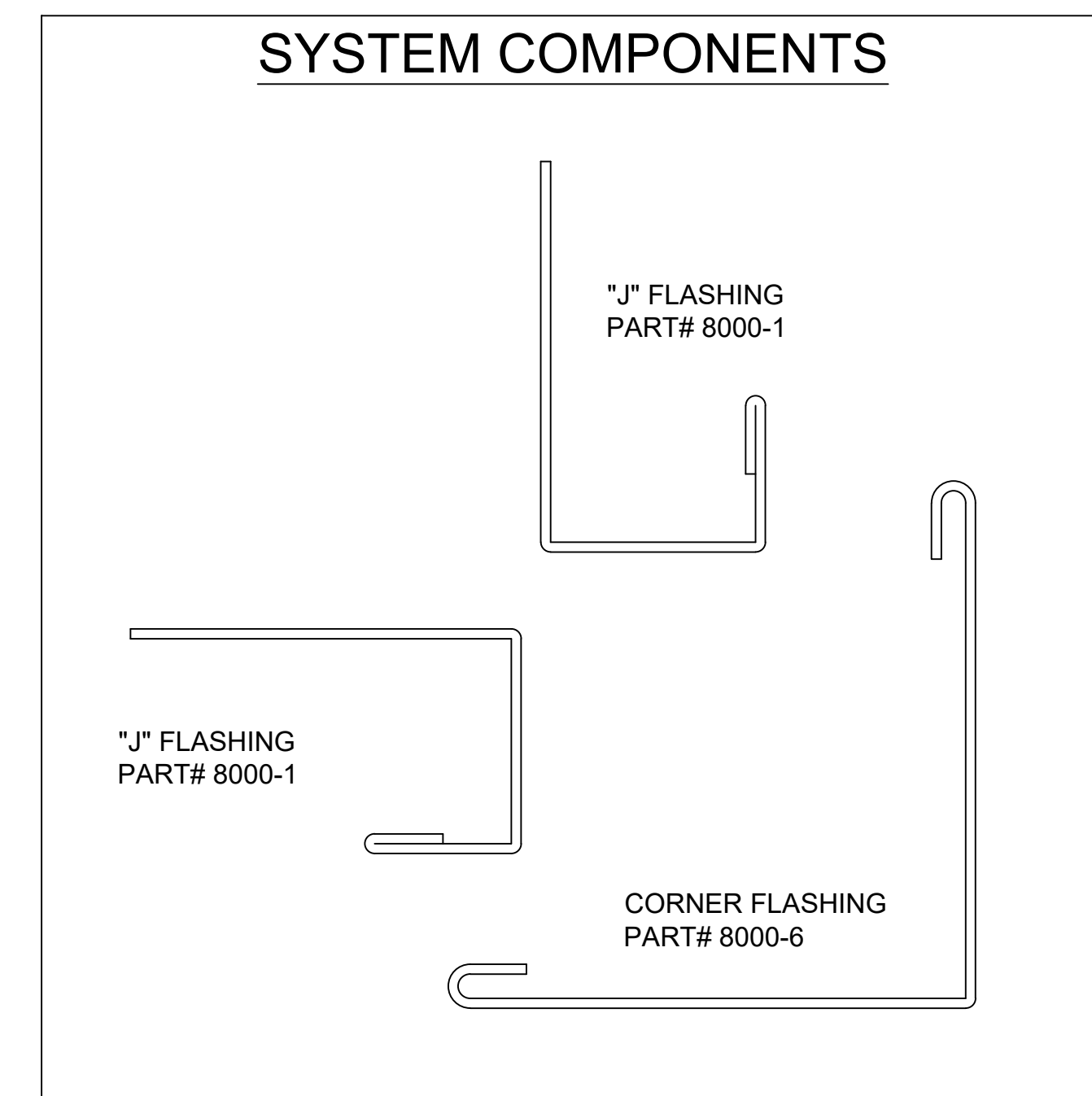
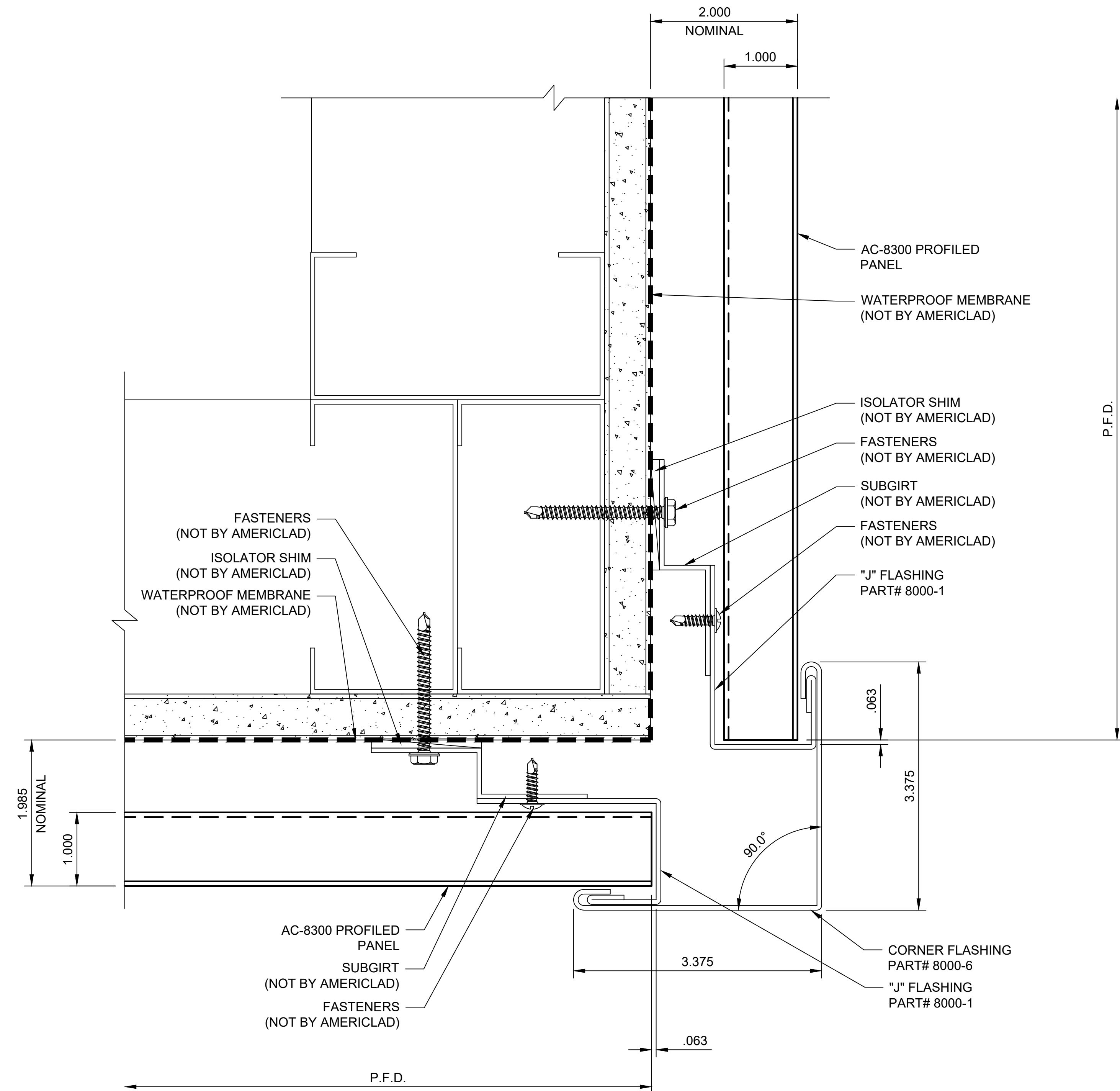

INSIDE CORNER PLAN DETAIL

DETAIL H

NOTE:
 LOAD BEARING WALL COMPONENTS OF EITHER: 16GA STEEL STUDS, STRUCTURAL MEMBERS, MINIMUM 3/4" PLYWOOD OR CONCRETE. GYPSUM BOARD AND CEMENT BOARD ARE NOT A STRUCTURAL COMPONENT.

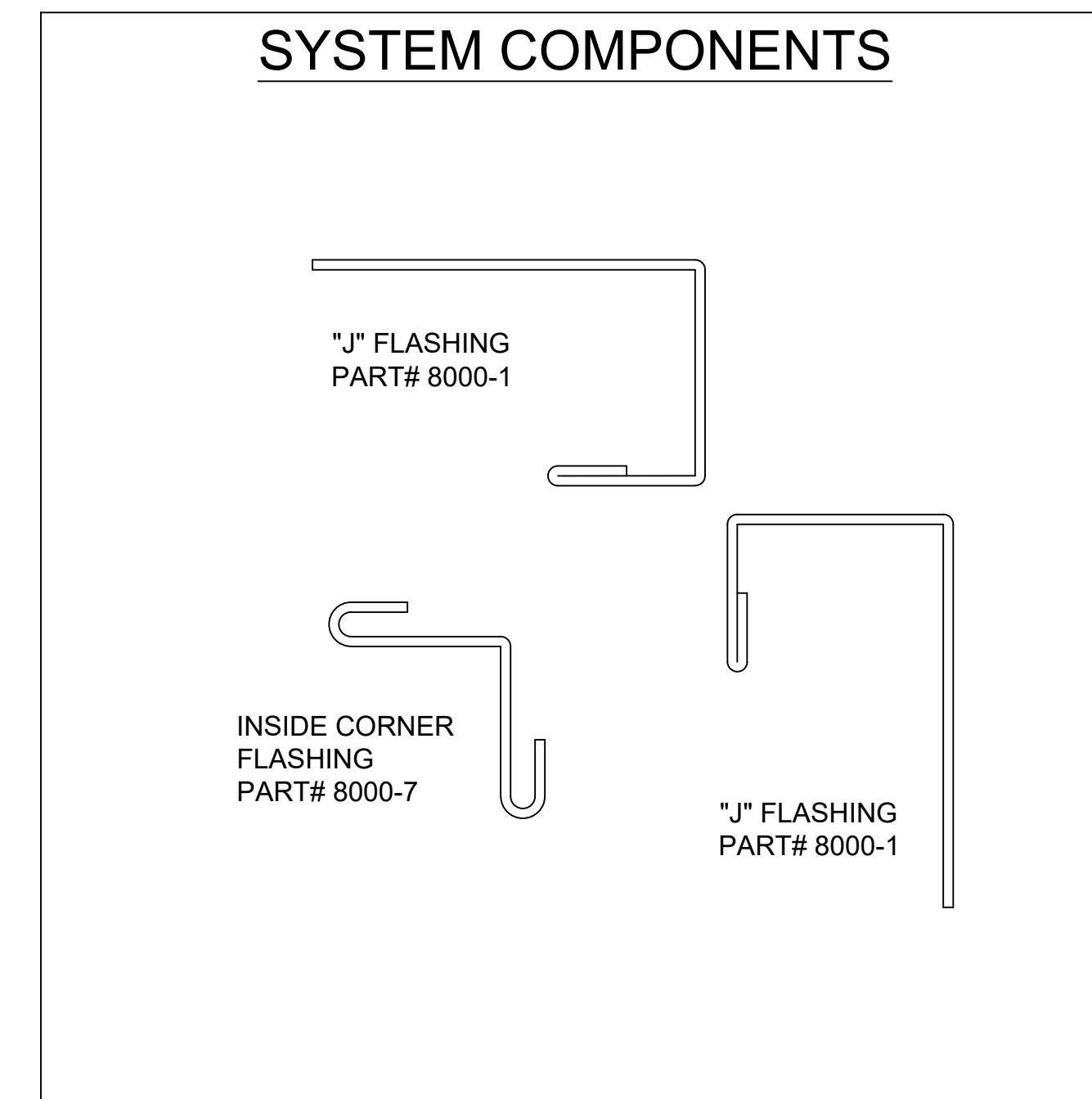
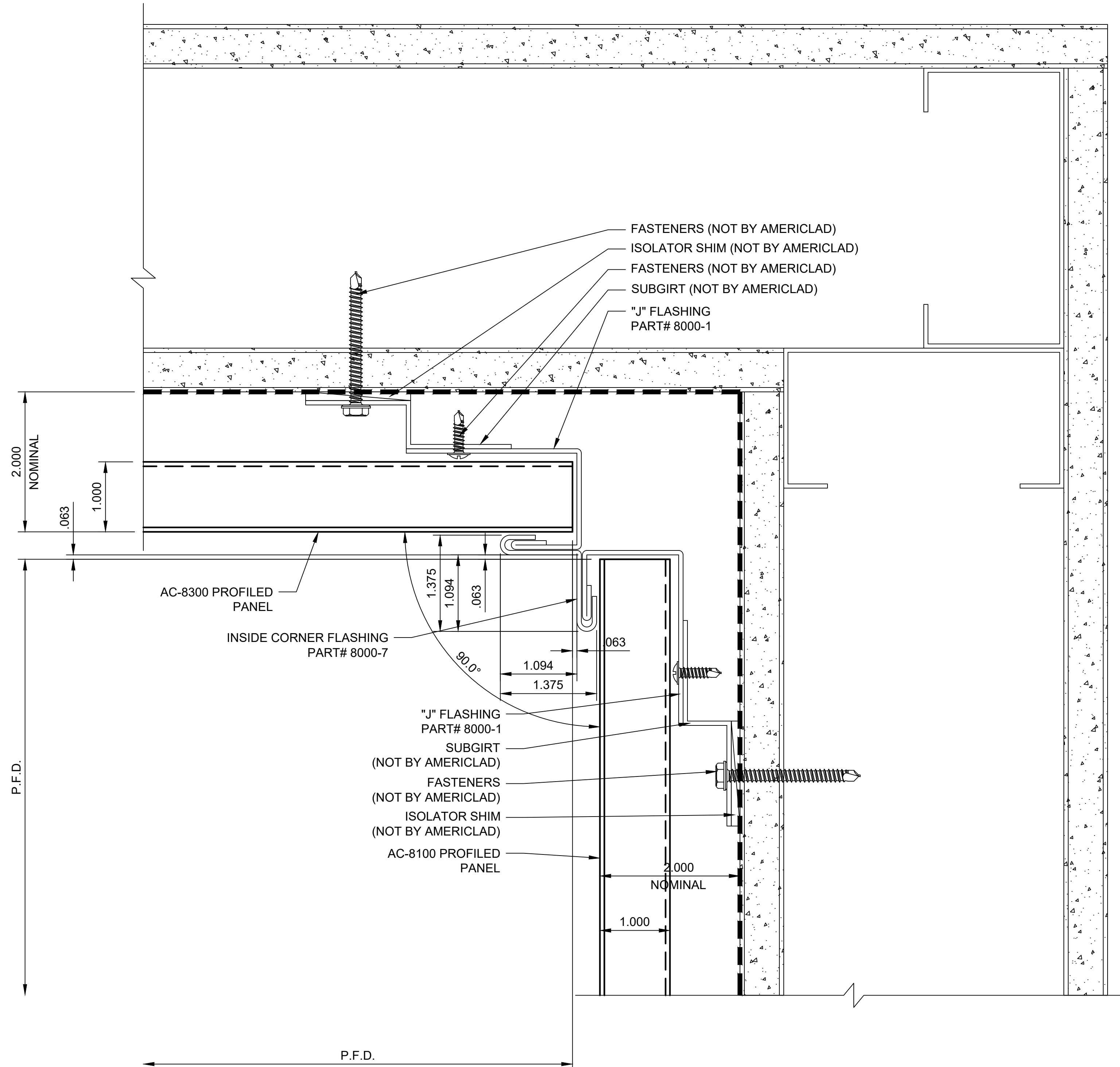

SECTION @ SOFFIT TRANSITION
DETAIL J

NOTE:
LOAD BEARING WALL COMPONENTS OF EITHER: 16GA STEEL STUDS, STRUCTURAL MEMBERS, MINIMUM 3/4" PLYWOOD OR CONCRETE. GYPSUM BOARD AND CEMENT BOARD ARE NOT A STRUCTURAL COMPONENT.

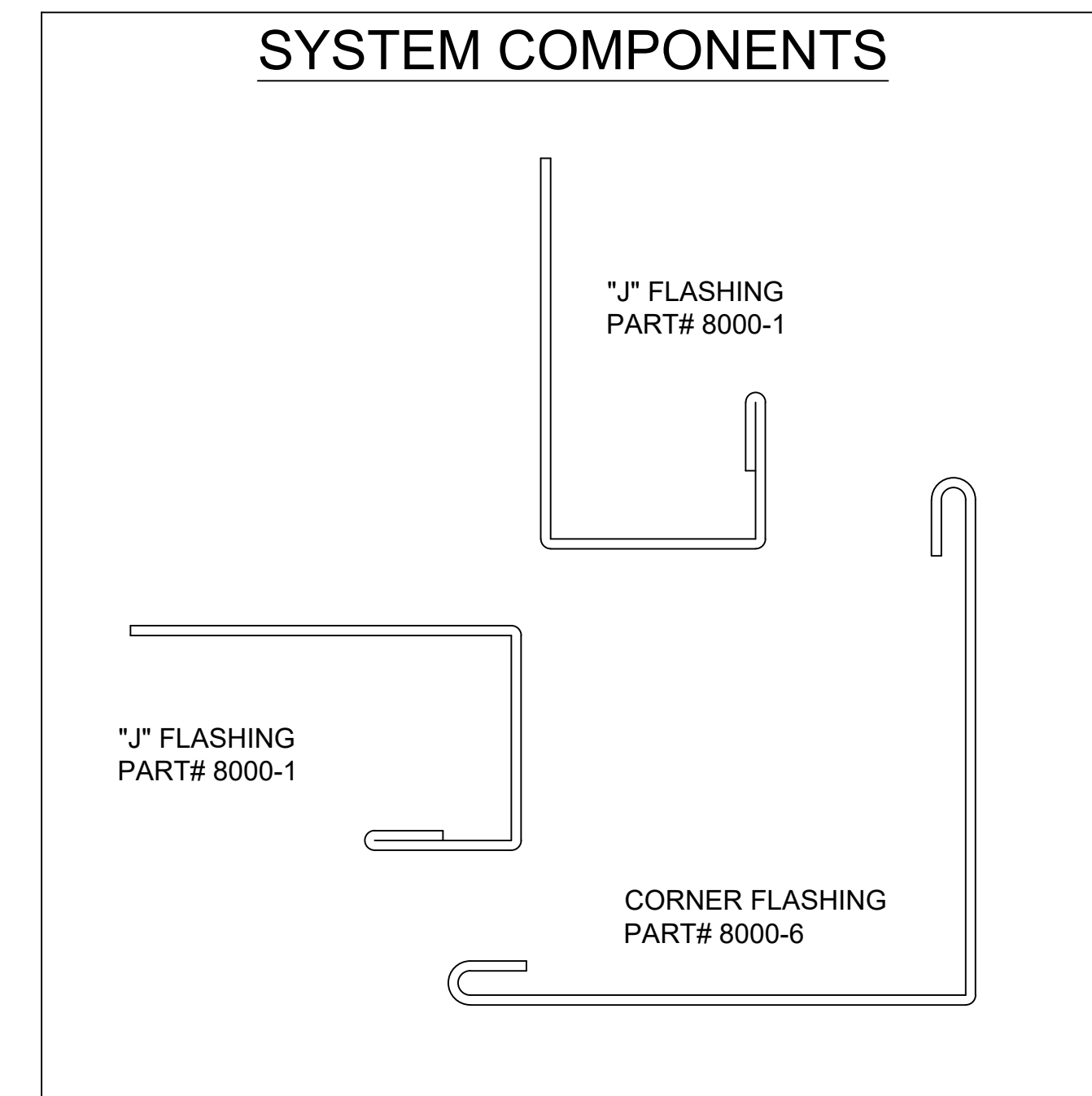
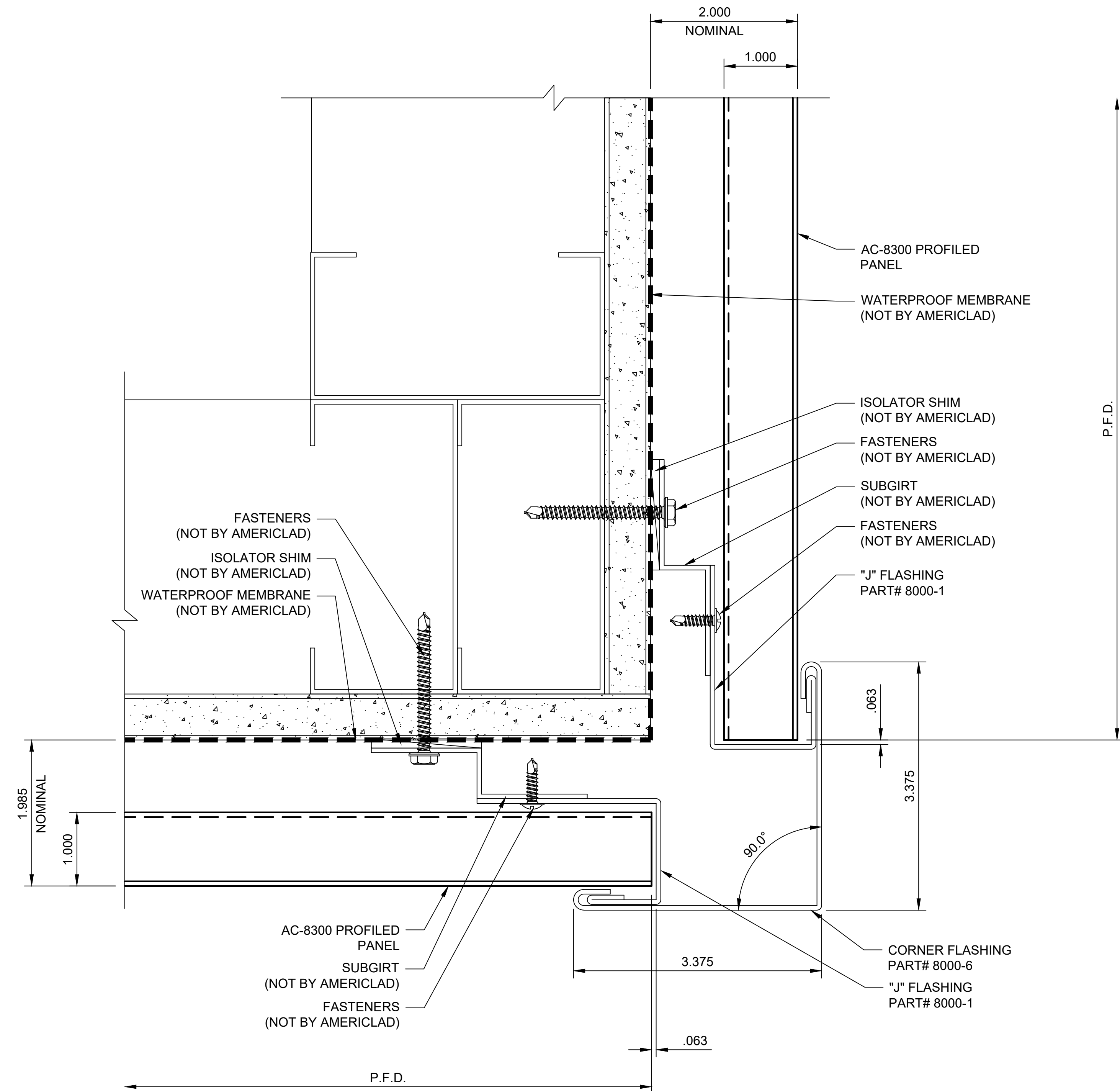

SECTION @ SOFFIT

DETAIL K

NOTE:
 LOAD BEARING WALL COMPONENTS OF EITHER: 16GA STEEL STUDS, STRUCTURAL MEMBERS, MINIMUM 3/4" PLYWOOD OR CONCRETE. GYPSUM BOARD AND CEMENT BOARD ARE NOT A STRUCTURAL COMPONENT.

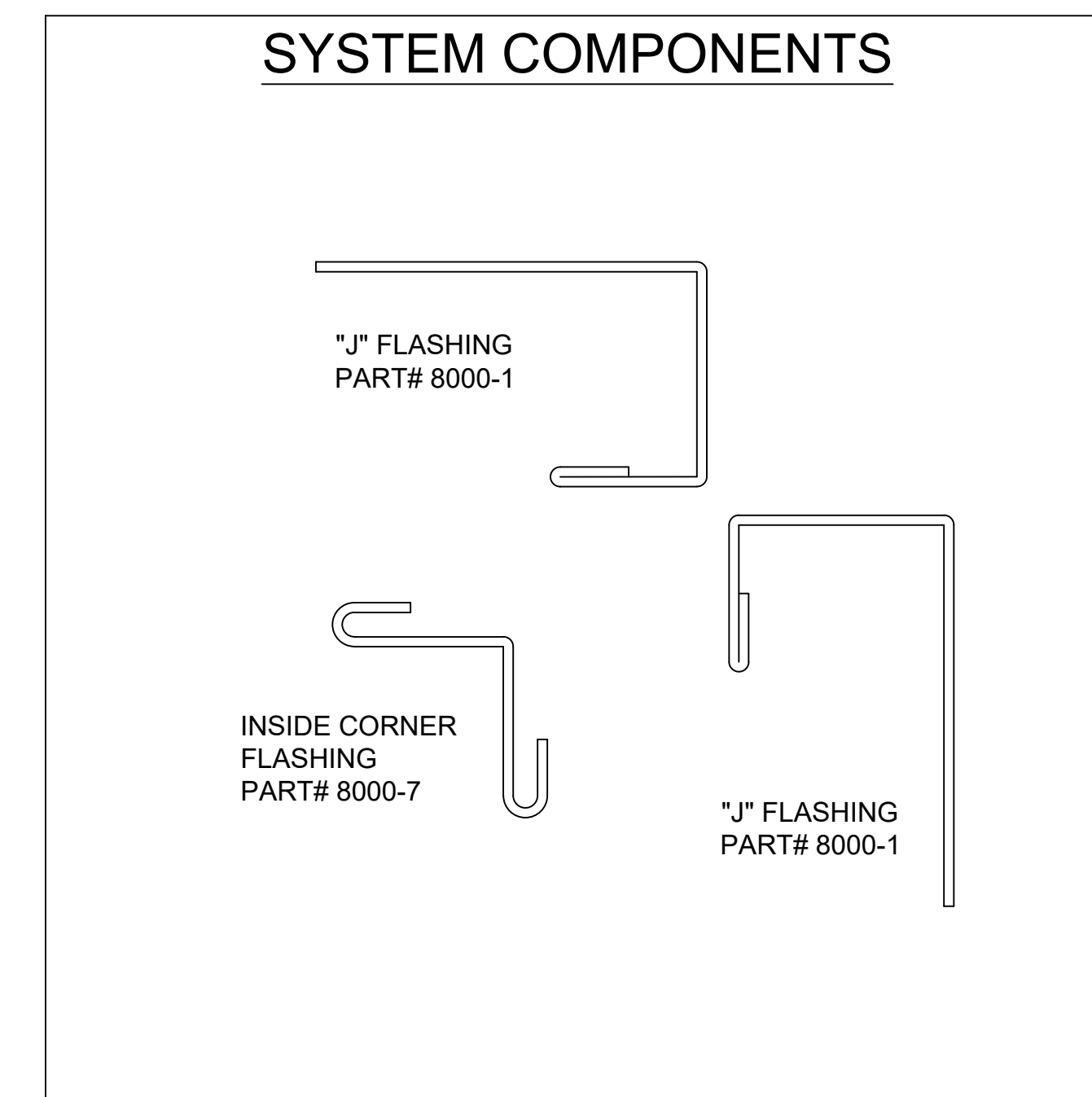
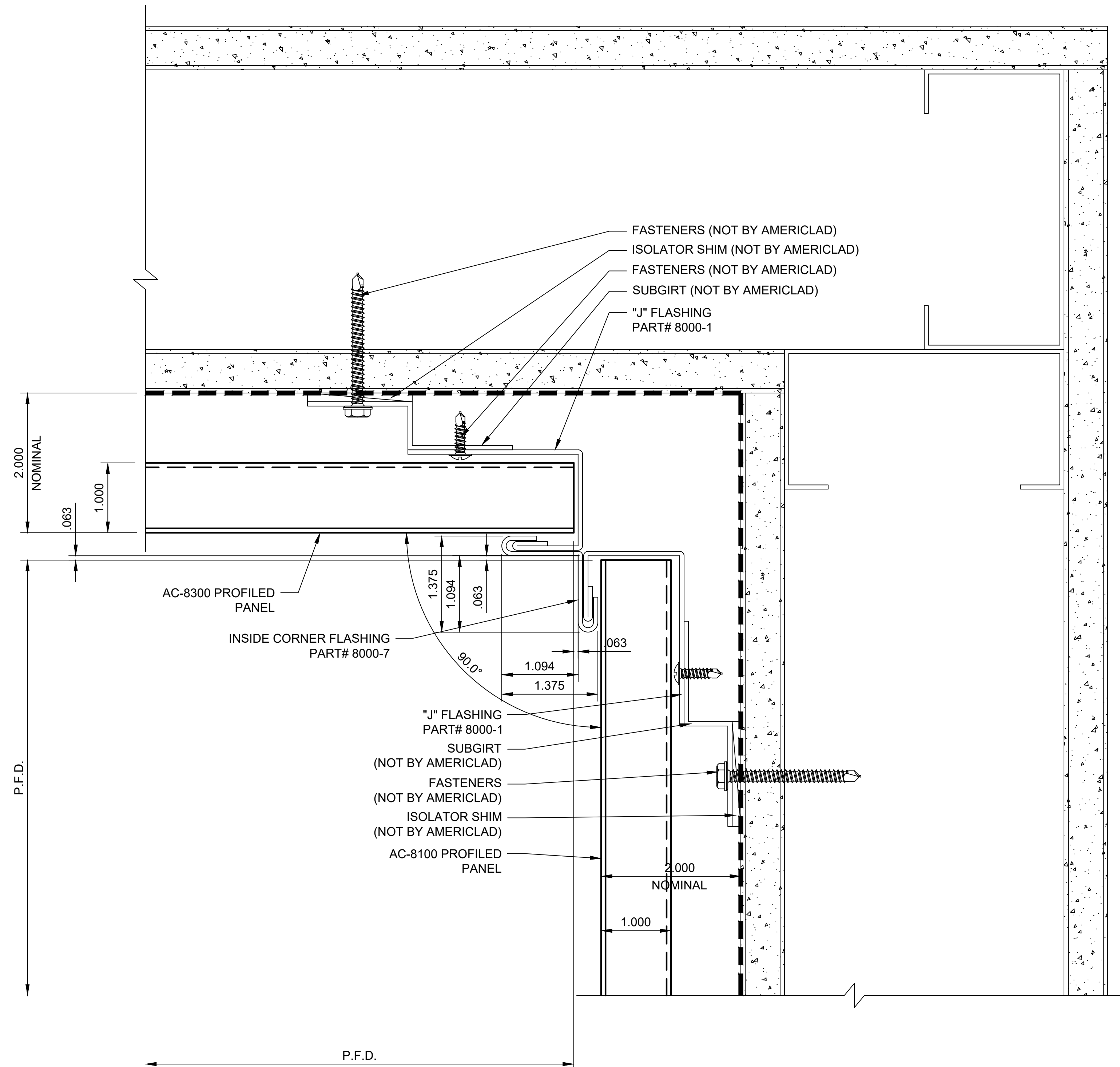

WINDOW SILL DETAIL

DETAIL L

NOTE:
LOAD BEARING WALL COMPONENTS OF EITHER: 16GA STEEL STUDS, STRUCTURAL MEMBERS, MINIMUM 3/4" PLYWOOD OR CONCRETE. GYPSUM BOARD AND CEMENT BOARD ARE NOT A STRUCTURAL COMPONENT.

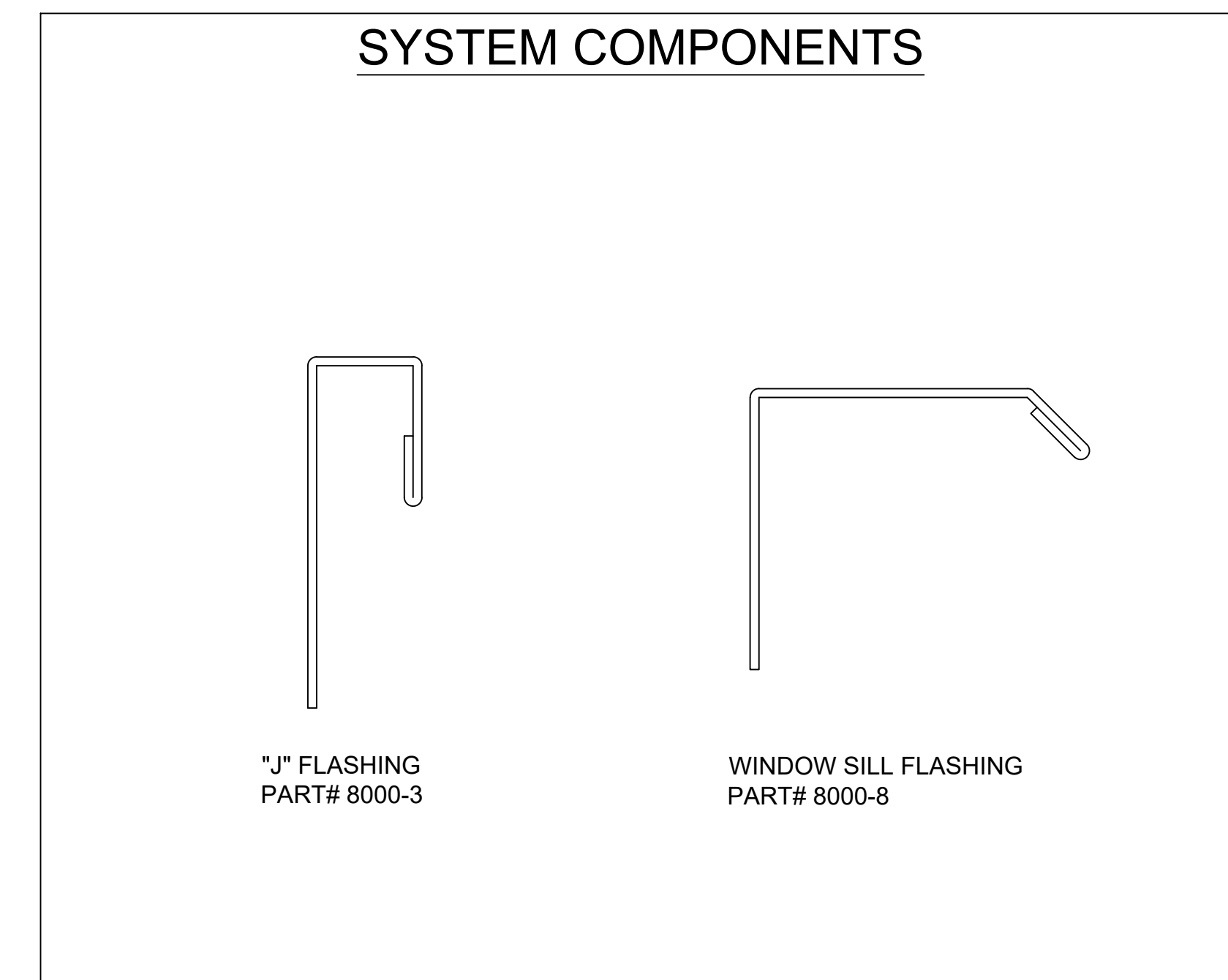
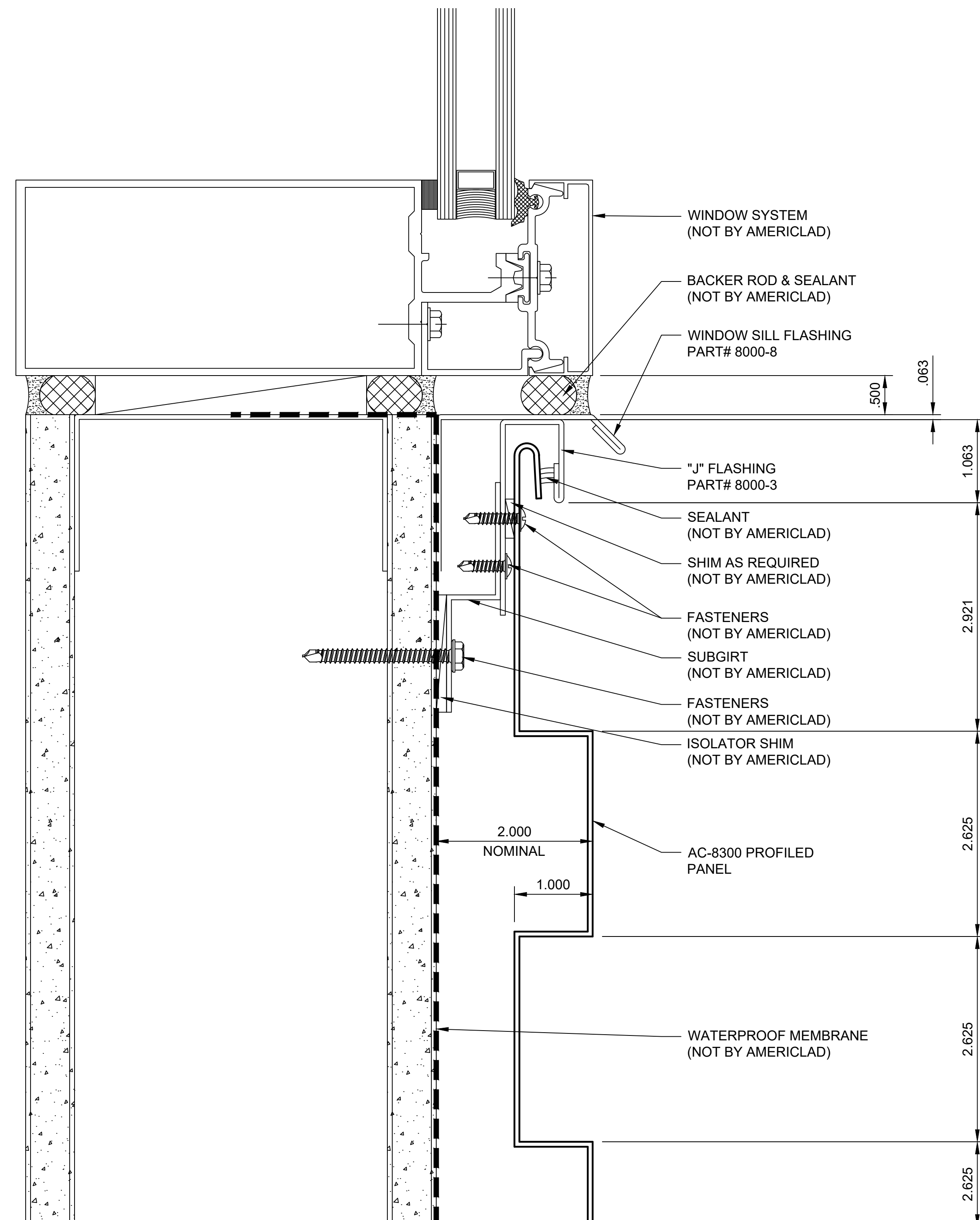

WINDOW HEAD DETAIL

DETAIL M

NOTE:
 LOAD BEARING WALL COMPONENTS OF EITHER: 16GA STEEL STUDS, STRUCTURAL MEMBERS, MINIMUM 3/4" PLYWOOD OR CONCRETE. GYPSUM BOARD AND CEMENT BOARD ARE NOT A STRUCTURAL COMPONENT.

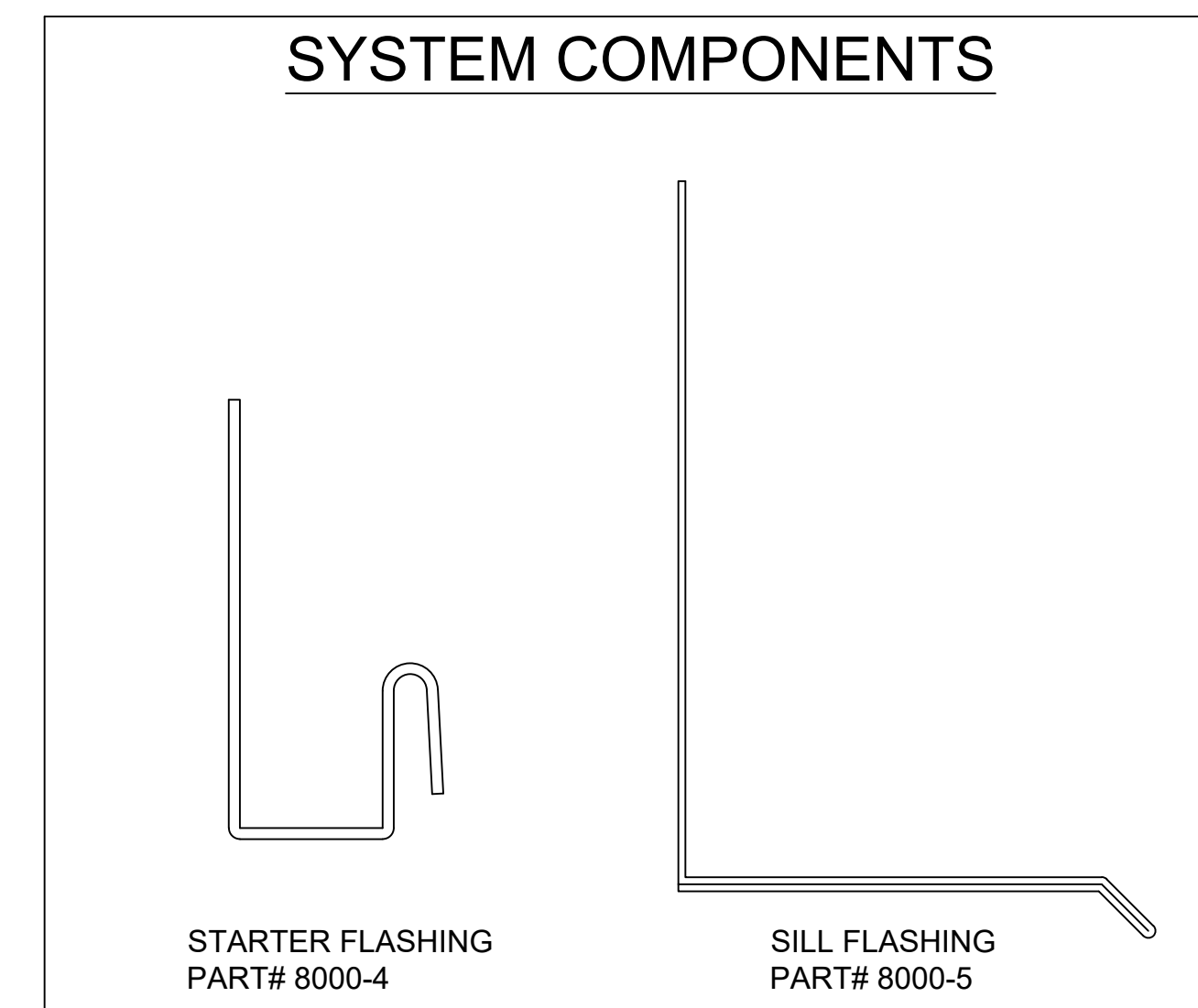
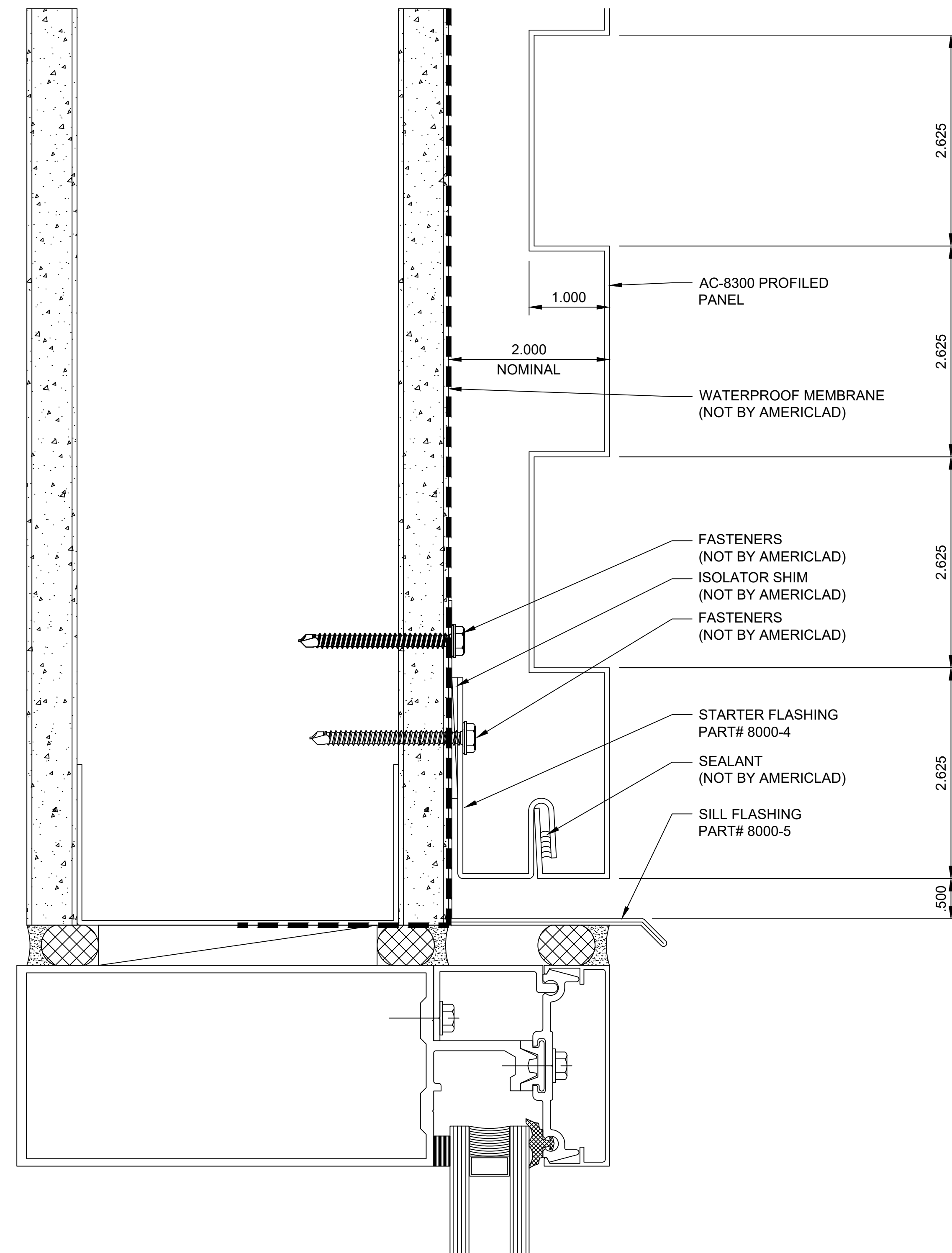

WINDOW JAMB DETAIL

DETAIL N

NOTE:
 LOAD BEARING WALL COMPONENTS OF EITHER: 16GA STEEL STUDS, STRUCTURAL MEMBERS, MINIMUM 3/4" PLYWOOD OR CONCRETE. GYPSUM BOARD AND CEMENT BOARD ARE NOT A STRUCTURAL COMPONENT.

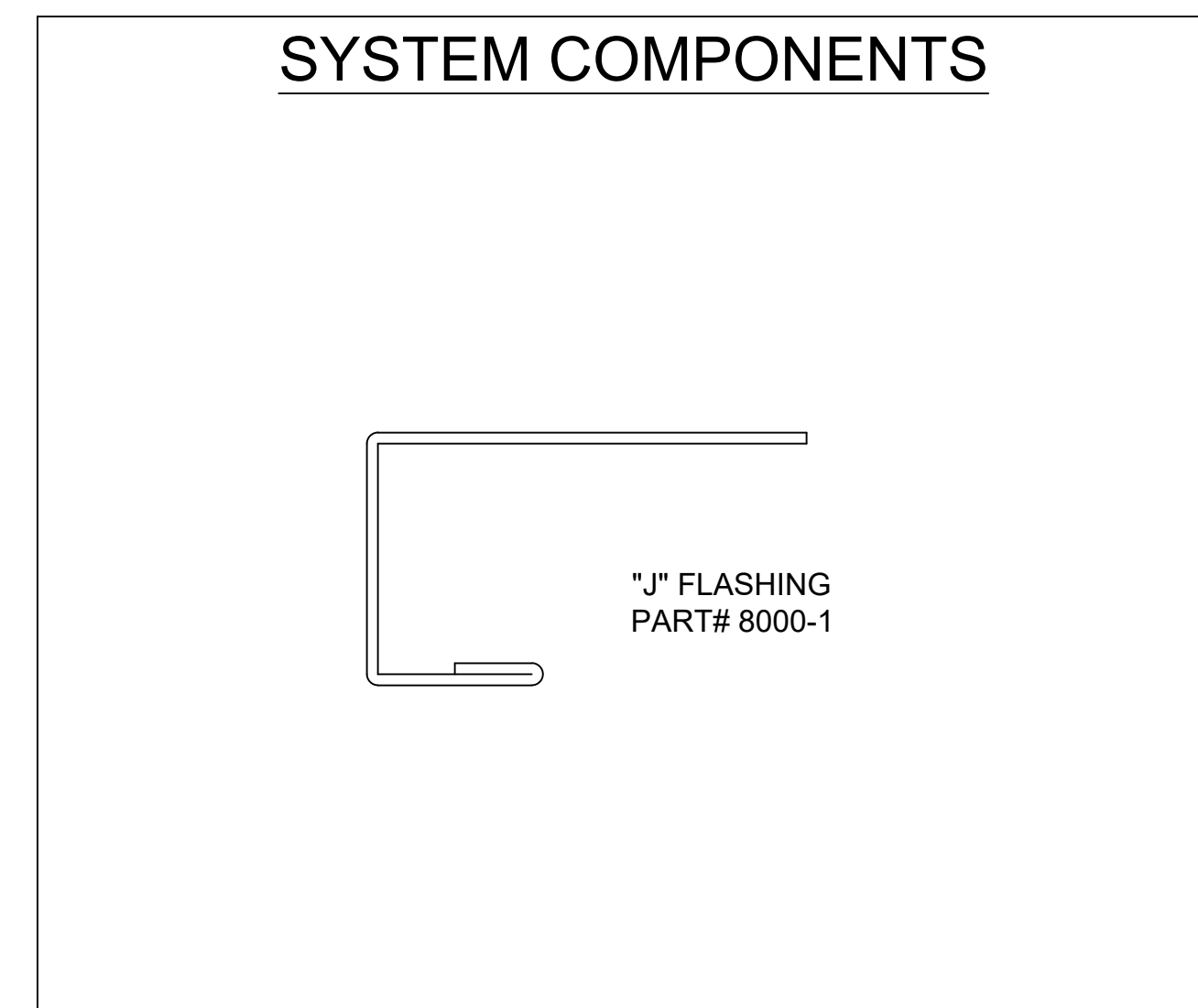
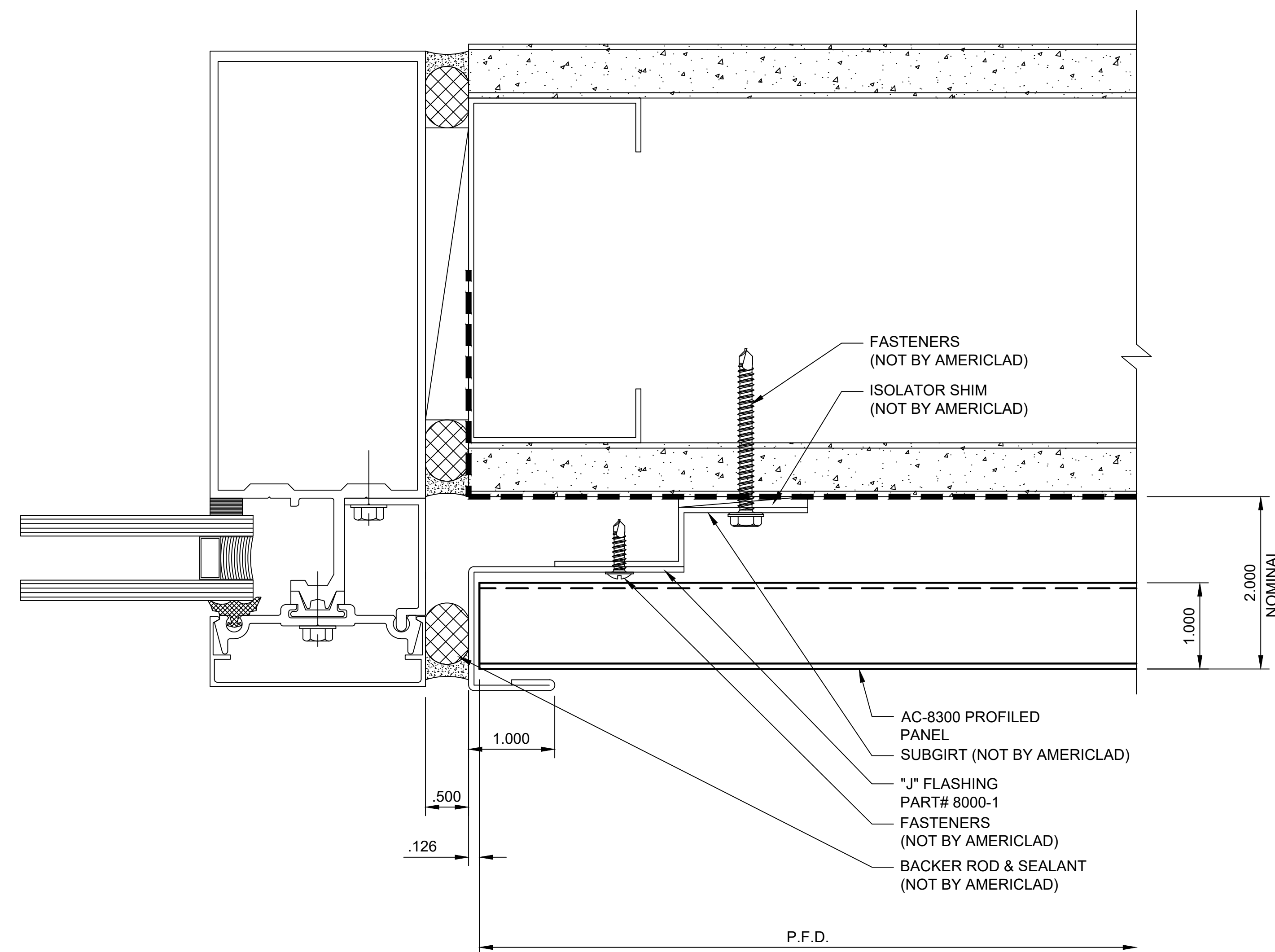

FLASHING PROFILES

DETAIL O

NOTE:
LOAD BEARING WALL COMPONENTS OF EITHER: 16GA STEEL STUDS, STRUCTURAL MEMBERS, MINIMUM 3/4" PLYWOOD OR CONCRETE. GYPSUM BOARD AND CEMENT BOARD ARE NOT A STRUCTURAL COMPONENT.

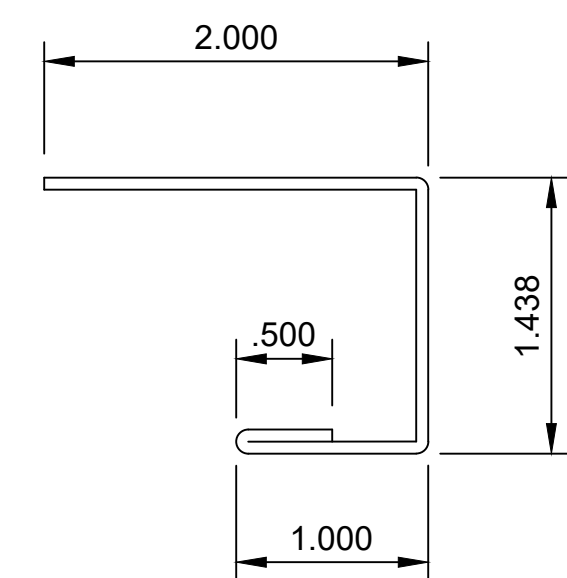

"J" FLASHING
PART# 8000-1
QTY:
10'-0" STOCK LENGTHS

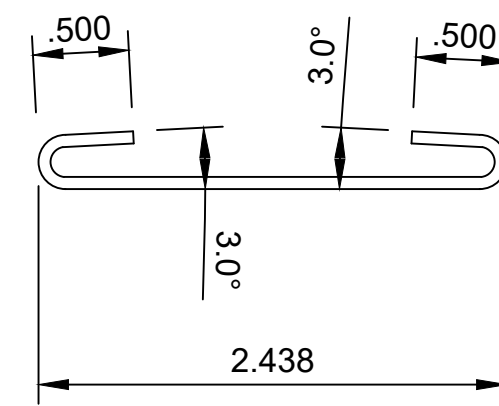

COVER FLASHING
PART# 8000-2
QTY:
10'-0" STOCK LENGTHS

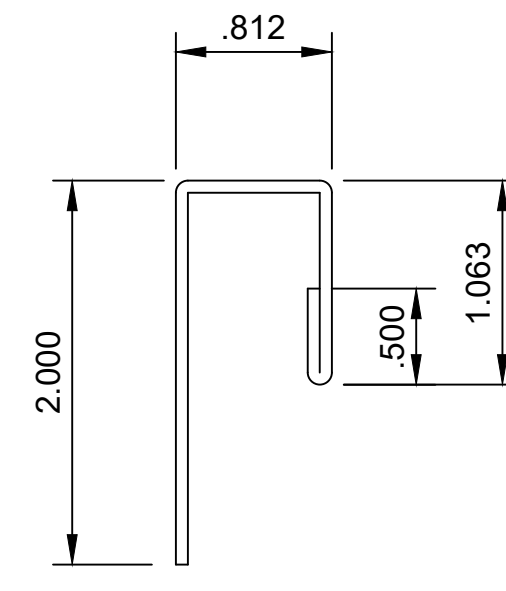

"J" FLASHING
PART# 8000-3
QTY:
10'-0" STOCK LENGTHS

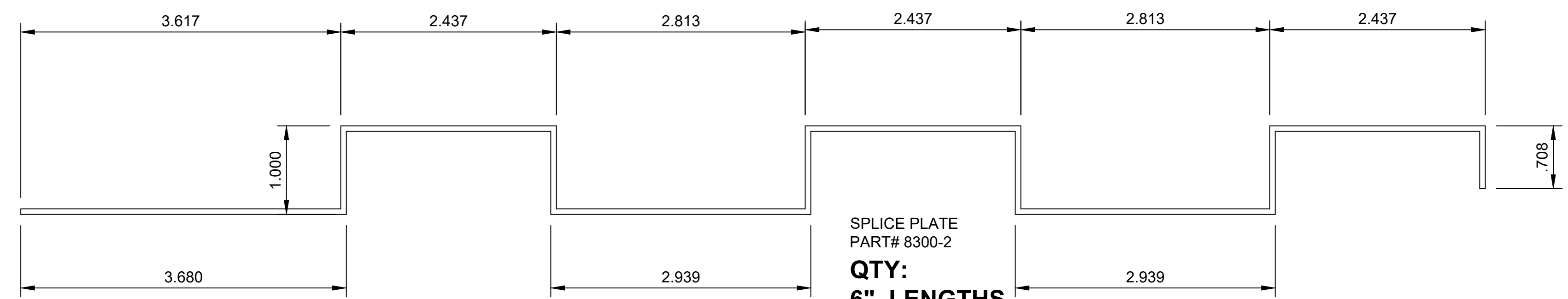

SPLICE PLATE
PART# 8300-2
QTY:
6" LENGTHS

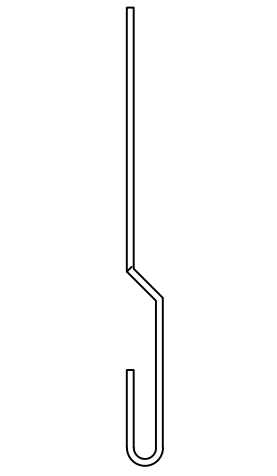

FLAT LOCK CLIP

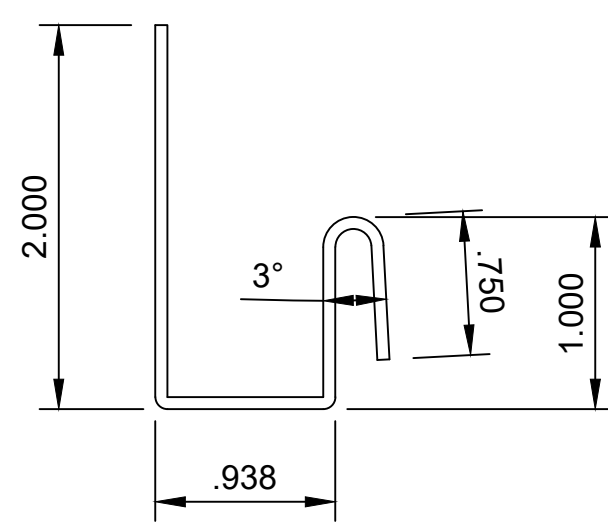

STARTER FLASHING
PART# 8000-4
QTY:
10'-0" STOCK LENGTHS

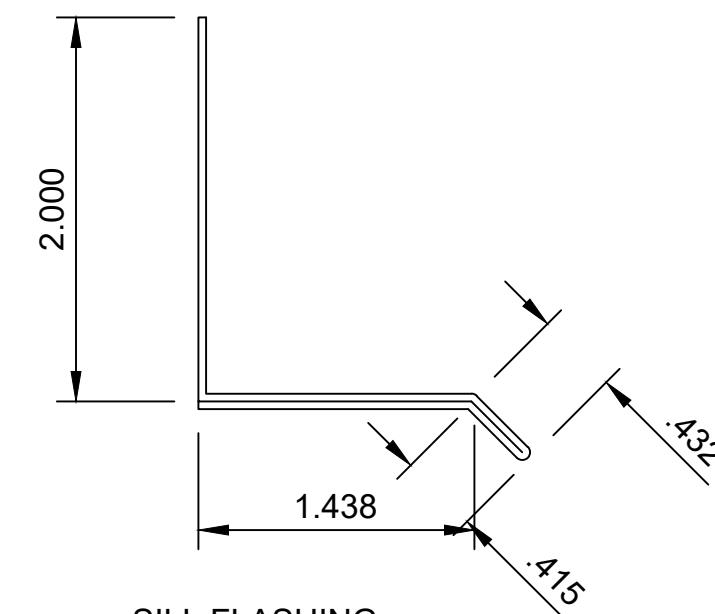

SILL FLASHING
PART# 8000-5
QTY:
10'-0" STOCK LENGTHS

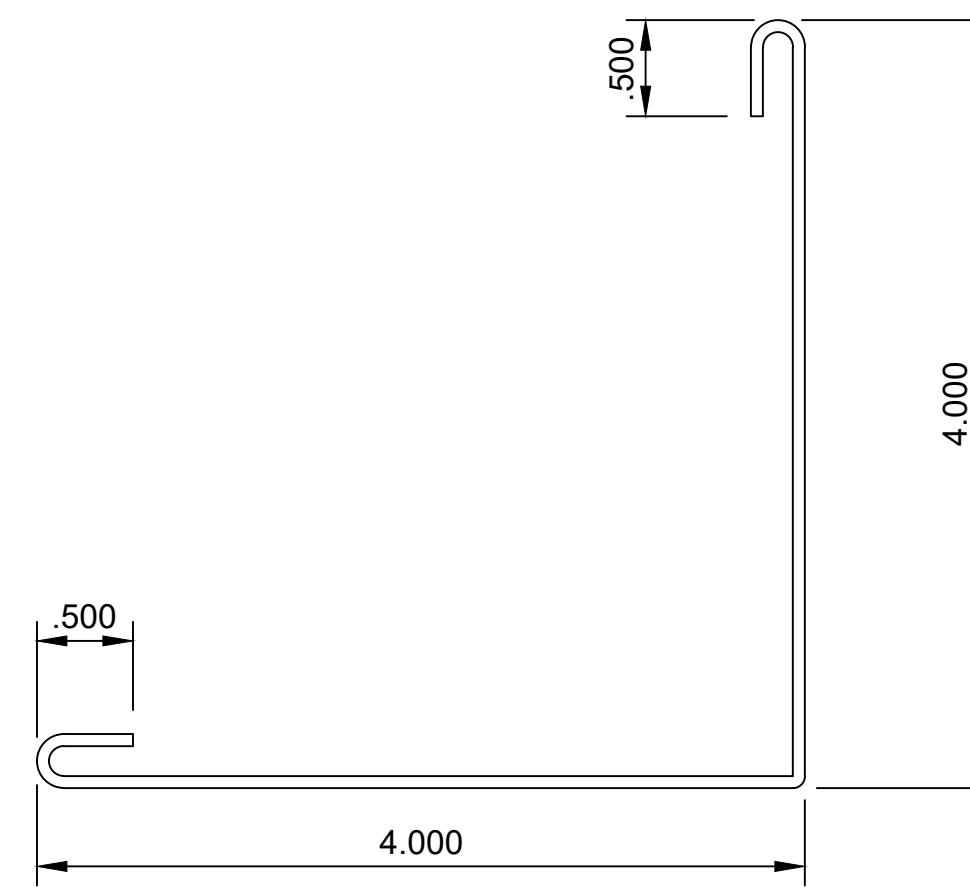

CORNER FLASHING
PART# 8000-6
QTY:
10'-0" STOCK LENGTHS

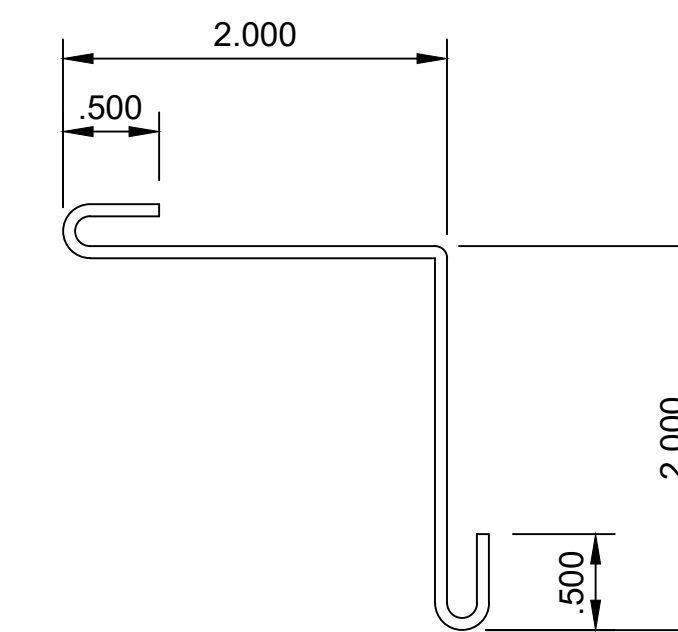

INSIDE CORNER
FLASHING
PART# 8000-7
QTY:
10'-0" STOCK LENGTHS

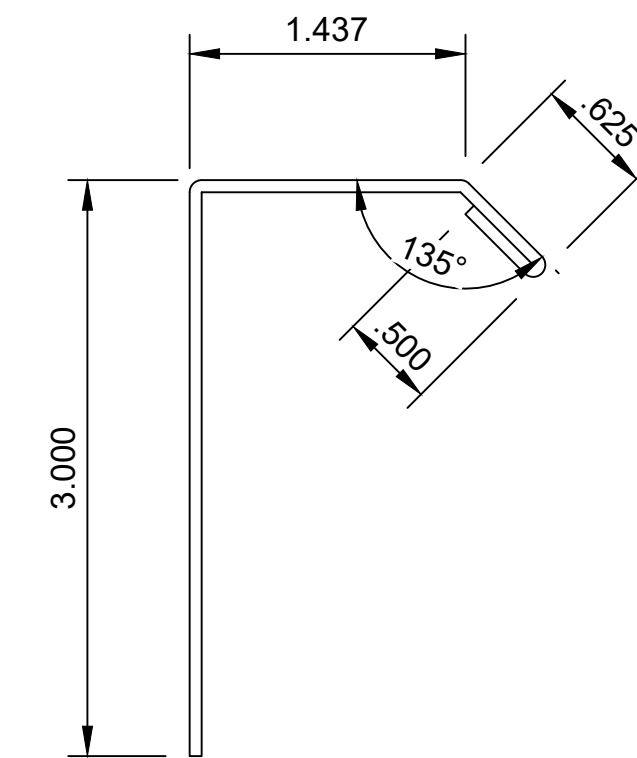

WINDOW SILL FLASHING
PART# 8000-8
QTY:
10'-0" STOCK LENGTHS

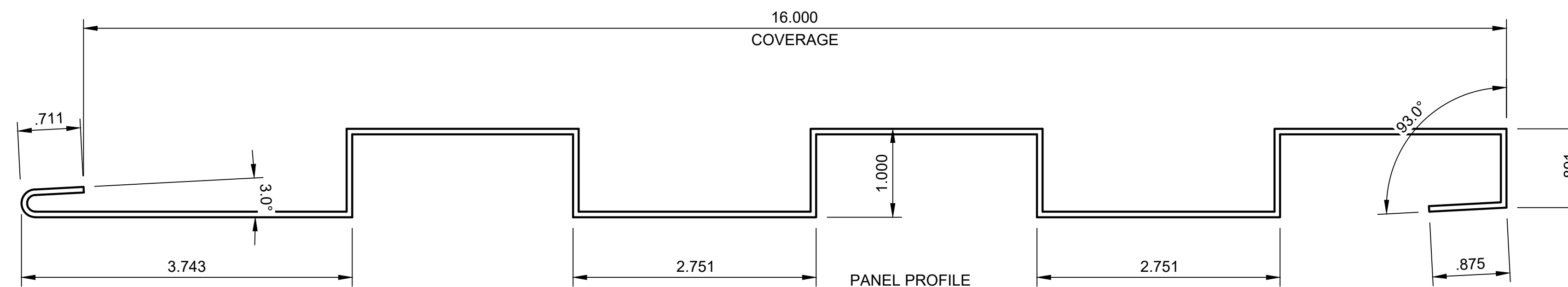

PANEL PROFILE
PART# 8300-1
QTY:
10'-0" STOCK LENGTHS